

ES1-275 R 4C 1277 4
RICHARD B FONES JR
25 BALTIMORE-ANNAPOLIS
BLVD-FERNDALE
GLEN BURNE MD 21061

July, 1975 □ 75 cents

JS

Electronic Servicing



A HOWARD W. SAMS PUBLICATION

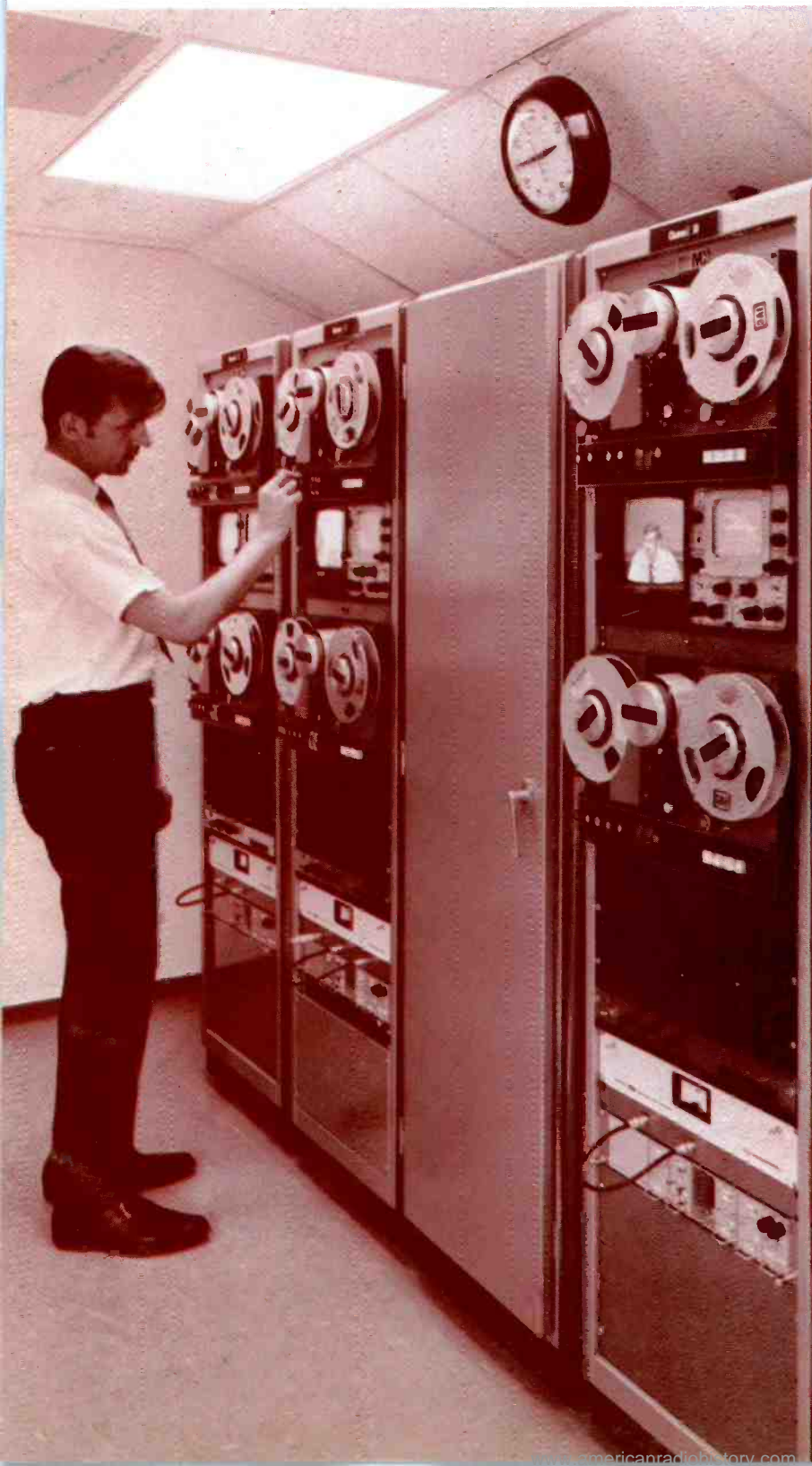

VIDEO TAPE
RECORDING

Practical
Bookkeeping

Quasar
Modular Color

Selective
Radio Calling

Let us solve your tuner problems

PTS will repair any tuner—no matter how old or new. Fastest Service—8 hour—in and out the same day. Overnight transit to one of our strategically located plants. Best Quality—you and your customers are satisfied.

PTS uses only ORIGINAL PARTS! No homemade or make-do, inferior merchandise (this is why we charge for major parts!). You get your tuner back in ORIGINAL EQUIPMENT condition.

PTS is recommended by more TV Manufacturers than any other tuner company and is overhauling more tuners than all other tuner services combined.

We're proud to announce the Grand Opening of our new Service Centers in Los Angeles, Columbus, Ohio, Phoenix, Boston, Norfolk & Milwaukee

Precision Tuner Service



ELECTRONICS, INC.



VHF, UHF \$10.95
UV-COMBO 17.95
IF-SUBCHASSIS . . 12.50

Major parts and shipping charged at cost. (Dealer net!)

Home Office	Bloomington, Indiana	47401	5233 S. Highway 37	812-824-9331
Alabama	Birmingham, Alabama	35222	524 32nd St. So.	205-323-2657
Arizona	Phoenix, Arizona	85061	2412 W. Indian School Rd.	602-279-8718
California	Los Angeles, Ca. Central	90023	4184 Pacific Way	213-266-3728
	Sacramento, Ca. No.	95841	4611 Auburn Blvd.	916-482-6220
	San Diego, Ca. So.	92105	5111 University Ave.	714-280-7070
Colorado	Arvada, Colorado	80001	4958 Allison St.	303-423-7080
Florida	Jacksonville, Fla. No.	32210	1918 Blanding Blvd.	904-389-9952
	Miami, Fla. So.	33168	12934 N.W. 7th Ave.	305-685-9811
Indiana	Bloomington, Ind.	47401	5233 S. Highway 37	812-824-9331
Kansas	Kansas City, Kansas	66106	3116 Merriam Lane	913-831-1222
Louisiana	Metairie, La.	70003	2914 Wytchwood Dr.	504-885-2349
Maryland	Silver Springs, Md.	20910	1105 Spring St.	301-565-0025
Massachusetts	Somerville, Mass.	02144	52 Holland St.	617-666-4770
	Springfield, Mass.	01103	191 Chestnut St.	413-734-2737
Michigan	Detroit, Mich.	48235	13709 W. 8 Mile Rd.	313-862-1783
Minnesota	Minneapolis, Minn.	55408	815 W. Lake St.	612-824-2333
Missouri	St. Louis, Mo.	63130	8456 Page Blvd.	314-428-1299
New Jersey	E. Paterson, N. Jersey	07407	158 Market St.	201-791-6380
New York	Buffalo, New York	14212	993 Sycamore St.	716-891-4935
North Carolina	Charlotte, N. Car.	28205	724 Seigle Ave.	704-332-8007
Ohio	Cinn., Ohio	45215	8180 Vine St.	513-821-2298
	Columbus, Ohio	43227	4003 E. Livingston Ave.	614-237-3820
	Parma, Ohio	44134	5682 C'tate Rd.	216-845-4480
Oklahoma	Oklahoma City, Ok.	73106	3007 N. May	405-947-2013
Oregon	Portland, Oregon	97213	5220 NE Sandy Blvd.	503-282-9636
Pennsylvania	Pittsburgh, Pa.	15202	257 Riverview Ave. W.	412-761-7648
	Upper Darby, Pa.	19082	1742-44 State Rd.	215-352-6609
Tennessee	Memphis, Tenn.	38118	3614 Lamar Ave.	901-365-1918
Texas	Houston, Texas	77032	4324-26 Telephone Ave.	713-644-6793
	Longview, Texas	75601	Mopac Rd.	214-753-4334
Virginia	Norfolk, Va.	23504	3118 E. Princess Anne Rd.	804-625-2030
Washington	Seattle, Wash.	98108	432 Yale Ave.	206-623-2320
Wisconsin	Milwaukee, Wis.	53215	3509 W. National	414-643-8800

PTS

IS
NUMBER ONE
AND
STILL
TRYING
HARDER

WE OFFER
FINER
FASTER
8 hr.
SERVICE

1 YEAR
GUARANTEE

NOT A
FRANCHISE
COMPANY

For More Details Circle (1) on Reply Card

For the Protection of ALL ELECTRONIC CIRCUITS

FUSETRON® dual-element — time-delay fuses

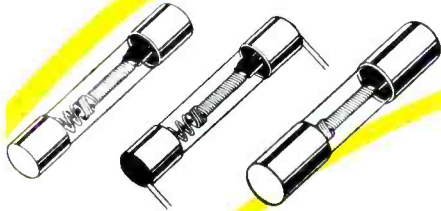

Avoid nuisance opening, yet get full short-circuit protection. Available from 1/100 amp. to 40. Size 1/4 x 1 1/4 in. and 9/32 x 1 1/4 in.

BUSS GLASS TUBE FUSES "quick-acting"

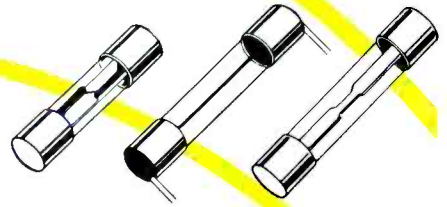

Provide high speed action to protect delicate instruments and apparatus. Available from 1/500 to 30 amp. Sixe 1/4 x 1 in. and 1/4 x 1 1/4 in.

TRON® rectifier fuses

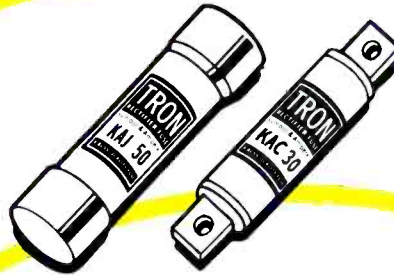

Provide extremely fast opening and high degree of restriction of let-thru current to protect Solid State Devices. Ampere rating 1/2 to 1000 in voltages up to 1500.

BUSS Signal-Indicating Alarm-Activating FUSES



Available with time-delay or quick-acting characteristics. Available from 1/10 to 30 amp. Size 1/4 x 1 1/4 in. and 13/32 x 1 1/2 in.

TRON® Sub-Miniature Pigtail Fuses

Size only .145 x .300 in. Glass tube permits visual inspection. Hermetically sealed. Available from 1/200 to 15 amp.



BUSS Fuses for TELEPHONE COMMUNICATIONS Similar equipment

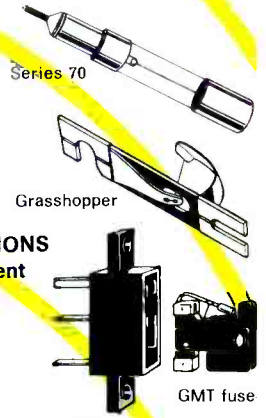

BUSS SNAP-LOCK FUSEHOLDER

Rear panel mount fuseholder for 1/4 x 1 1/4 in. fuses. Snaps into place. Specify HTA-00 for space saver type. HLD-00 to take visual indicating fuses. HKP-00 for standard fuseholder. HJM-00 to take 1/4 x 1 in. fuses.



BUSS Sub-Miniature GMW fuse



and HWA fuseholder. Full size 270 x .250 in. with window to check fuse element. Available 1/200 to 5 amp.



HKP panel mounted fuseholder for 1/4 x 1 1/4 in. fuses.



HKA lamp indicating, signal-activating fuseholder.

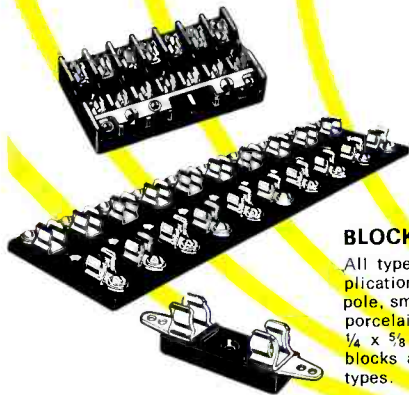

BLOCKS FOR BUSS FUSES

All types available for every application. Single pole, multiple pole, small base, laminated base, porcelain base for fuses from 1/4 x 5/8 in. up. Also signal fuse blocks and special blocks of all types.

BUSS® FUSES

For Quality — Reliability

For anything you need in protecting electronic circuits and devices —

Write for Bulletin SFB

— See for yourself —



BUSSMANN MANUFACTURING
a McGraw-Edison Company Division
St. Louis, Missouri 63107



electronicscanner

news of the industry

Quasar Electronics Corporation has introduced 3 color TV sets in 13- and 15-inch screen sizes featuring a new QMX-1 chassis, advanced in-line Quintrix color TV picture tubes, and Super-Insta-Matic tuning which automatically adjusts picture brightness to room light levels. **Home Furnishings Daily** reports the company is planning from 4- to 6% price increases on new models over comparable 1975 models.

During the early morning rush hours in New York City recently, 200-to-300 members of service associations demonstrated against segments they believe to be unconstitutional of the city's TV License Law and Regulation. The regulations state a customer is entitled to receive in the mail a written estimate for all TV, radio, and audio repairs before work is begun, and a service dealer must guarantee his work for 30 days and parts replaced for 90 days. The demonstrators were members of the New York Service Managers Association, the Association of Home Appliance Services, and the Metropolitan Electronic Television Service Dealers Association (METSDA). The three groups filed a suit against the New York City Consumer Affairs Department, asking the State Supreme Court to declare the law unconstitutional. The groups seek a preliminary injunction barring enforcement of the law until the case is decided, which will not be for months, reports **Home Furnishings Daily**. A representative of the groups said cost of repairs in the city will have to be increased by 25% to cover increased costs for mailing and administrative work.

The Electrical Industries Association (EIA) of southern California has made consumer arbitration available to its 600 members. Members have promised to undergo arbitrations for any complaints consumers want resolved, at no cost to the EIA member, nor to the consumer, reports **Home Furnishings Daily**. The local Better Business Bureau office handles the mechanics. Art Schwartz, EIA executive vice-president, said that by agreeing to offer arbitration, members strengthen their credibility in willingness to meet consumer demands, and the image of the retailer is improved.

National Electronic Service Dealers Association will hold the annual NESDA service convention at the Hyatt House Hotel and Red Benton Convention center in Winston-Salem, North Carolina August 12th through 17th. Mr. Dick Pavek, President of Tech Spray, will give the keynote address on Thursday afternoon. Also, Thursday will be the date for the Business Management School, Friday is the Circus combined with the manufacturer's displays, and technical seminars and CET tests are scheduled for Saturday. Frank McLaughlin, of the Office of Consumer Affairs, will speak at 5 PM Thursday; Jesse A. Bogen, from the Council of BBB, conducts a 2-hour seminar covering arbitration and warranty laws on Saturday PM; and John Phelan of the FTC will be featured. Jack Wayman will explain the many projects EIA is doing to improve service and enlist technicians. A golf tournament will be sponsored by the Finney Company, with M. L. Finneburgh, Sr., EHF, in charge. ISCET is scheduled for a mass Serviceability Inspection, with the participation of all attending CET's. Election of ISCET officers will be on Sunday. NESDA is at 1715 Expo Lane, Indianapolis, Indiana 46224.

(Continued on page 6)

TUNER SERVICE CORPORATION

SUBSTITUNER



INTRODUCING
AT JUST

\$39.95
U.S.A. ONLY

WITH CABLES

ONE YEAR
GUARANTEE



STILL ONLY

\$9.95
U.S.A. ONLY

ALL PARTS
INCLUDED

EXCEPT TUBES
AND TRANSISTORS

FEATURES

- A UHF Tuner with 70 channels which are detented and indicated just like VHF channels.
- A VHF Hi Gain Solid State Tuner.
- AC Powered
- 90 Day Warranty

Demonstrate the **SUBSTITUNER** to your customers and show improved reception with their TV sets.

You may place your order through any of the Centers listed below.

PROVIDES YOU WITH A COMPLETE SERVICE FOR ALL YOUR TELEVISION TUNER REQUIREMENTS.

REPAIR

VHF OR UHF ANY TYPE (U.S.A. ONLY) \$ 9.95
UHF/VHF COMBINATION (U.S.A. ONLY) \$15.00

- IN THIS PRICE ALL PARTS ARE INCLUDED. Tubes, transistors, diodes, and nuvistors are charged extra. This price does not include mutilated tuners.
- Fast, efficient service at our conveniently located Service Centers.
- All tuners are ultrasonically cleaned, repaired, realigned, and air tested.

REPLACE

UNIVERSAL REPLACEMENT TUNER \$12.95 (U.S.A. only)

- This price buys you a complete new tuner built specifically by Sarkes Tarzian Inc. for this purpose.
- All shafts have a maximum length of 10½" which can be cut to 1½".
- Specify heater type parallel and series 450 mA. or 600 mA.

CUSTOMIZE

- Customized tuners are available at a cost of only \$15.95. With trade-in \$13.95. (U.S.A. only)
- Send in your original tuner for comparison purposes to any of the Centers listed below.



WATCH US
GROW

HEADQUARTERS	BLOOMINGTON, INDIANA 47401	537 South Walnut Street	Tel. 812-334-0411
ARIZONA	TUCSON, ARIZONA 85713	P.O. Box 4534, 1528 S. 6th Ave.	Tel. 602-791-9243
CALIFORNIA	NORTH HOLLYWOOD, CALIF. 91601	10654 Magnolia Boulevard	Tel. 213-769-2720
	BURLINGAME, CALIF. 94010	1324 Marsten Road	Tel. 415-347-5728
	MODESTO, CALIF. 95351	123 Phoenix Avenue	Tel. 209-521-8051
FLORIDA	TAMPA, FLORIDA 33606	1505 Cypress Street	Tel. 813-253-0324
	FT. LAUDERDALE, FLORIDA 33315	104 S.W. 23rd St., Bay A	Tel. 305-524-0914
GEORGIA	ATLANTA, GA. 30310	646 Evans St. S.W.	Tel. 404-758-2232
ILLINOIS	CHAMPAIGN, ILLINOIS 61820	405 East University Street	Tel. 217-358-6400
	CHICAGO, ILLINOIS 60621	737 West 55th Street	Tel. 312-873-5556-7
	SKOKIE, ILLINOIS 60076	5110 West Brown Street	Tel. 312-675-0230
INDIANA	HAMMOND, INDIANA 46323	6833 Grand Avenue	Tel. 219-845-2676
	INDIANAPOLIS, INDIANA 46204	112 West St. Clair Street	Tel. 317-632-3493
IOWA	WEST DES MOINES, IOWA 50265	822 Tenth Street	Tel. 515-277-0155
KENTUCKY	LOUISVILLE, KENTUCKY 40208	2920 Taylor Boulevard	Tel. 502-634-3334
LOUISIANA	SHREVEPORT, LOUISIANA 71104	3025 Highland Avenue	Tel. 518-221-3027
MARYLAND	BALTIMORE, MARYLAND 21215	5505 Reisterstown Rd., Box 2824	Tel. 801-358-1186
MASSACHUSETTS	SPRINGFIELD, MASS. 01108	405 Dickinson St.	Tel. 413-788-8206
MISSOURI	ST. LOUIS, MISSOURI 63132	10530 Page Avenue	Tel. 314-429-0633
NEVADA	LAS VEGAS, NEVADA 89102	742 Western Avenue No. 1	Tel. 702-384-4235
NEW JERSEY	TRENTON, NEW JERSEY 08638	901 North Olden Avenue	Tel. 609-393-0999
	JERSEY CITY, NEW JERSEY 07307	547-49 Tronelle Ave., Hwy 1 & 9	Tel. 201-792-3730
OHIO	CINCINNATI, OHIO 45216	7450 Vine Street	Tel. 513-821-5080
	CLEVELAND, OHIO 44109	4525 Pearl Road	Tel. 216-741-2314
OREGON	PORTLAND, OREGON 97210	1732 N.W. 25th Avenue	Tel. 503-222-9059
TENNESSEE	GREENEVILLE, TENNESSEE 37743	1215 Snapps Ferry Road	Tel. 615-639-8451
	MEMPHIS, TENNESSEE 38111	3158 Barron Avenue	Tel. 901-458-2355
TEXAS	DALLAS, TEXAS 75218	11540 Garland Road	Tel. 214-327-8413
VIRGINIA	NORFOLK, VIRGINIA 23513	3295 Santos Street	Tel. 804-855-2518
WISCONSIN	MILWAUKEE, WISCONSIN 53216	4722 W. Fond Du Lac Ave.	Tel. 414-871-7655
CANADA	ST. LAURENT, QUEBEC HAN-2L7	305 Decarie Boulevard	Tel. 514-748-8803
	CALGARY, ALBERTA T2H-0L1	448 42nd Avenue S.E.	Tel. 403-243-0971
		P.O. Box 5823, Stn. "A"	

IF YOU WANT TO BRANCH OUT INTO THE TV TUNER REPAIR BUSINESS, WRITE TO THE BLOOMINGTON HEADQUARTERS ABOUT A FRANCHISE.

For More Details Circle (3) on Reply Card

www.americanradiohistory.com

(Continued from page 4)

An experimental model of a large-area liquid-crystal display system has been developed jointly by Hitachi, Ltd., Dai Nippon Toryo Company, Ltd., and Asahi Glass Company, Ltd. The panel can selectively display at one time up to 600 characters of alphanumeric or Japanese "Kana" types, with each character formed by 7X9 dots. Liquid crystal is a fluid, transparent organic compound, and the transparency changes with application of voltage. Using a dynamic scattering mode, the panel indicates characters by a whitening of the liquid crystal material when voltage is applied. The panel reportedly operates on low voltage with fractional power consumption.

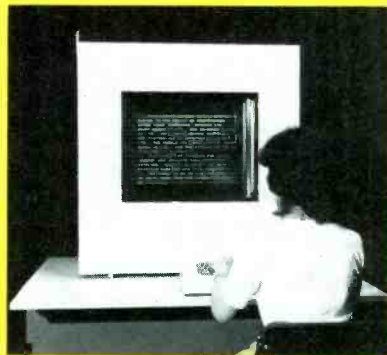

(Photo courtesy of Hitachi, Ltd.)

August 7-10 has been chosen by the **National Alliance of Television & Electronic Service Associations (NATESA)** for the 1975 national convention to be held at Pheasant Run in St. Charles, Illinois. A full agenda is planned, including business and technical meetings, Certification Tests, sponsored meals with messages from industry leaders, hospitality suites, and banquets with floor show. St. Charles is a suburb of Chicago, and Pheasant Run is an interesting recreational resort with dinner theater, swimming, golf, tennis, horseback riding, a Dixieland band, and quaint shops. Send a donation check for \$25 per person to: NATESA, 5908 South Troy, Chicago, Illinois 60629.

Nine of the largest TV manufacturers in the United States have been named in a \$6.3 million lawsuit in California, charging them with conspiring to fix prices paid independent servicers for performing warranty work on their products. According to an article in **Home Furnishings Daily**, Admiral, Curtis Mathes, General Electric, Magnavox, Quasar, Packard Bell, Panasonic, Sylvania, and Zenith have been charged with "destroying competition" by soliciting warranty work at a price below the actual cost.

PTS Electronics, Inc. has opened two service centers where previously no tuner service was available. The addresses are: 432 Yale Avenue, Seattle, Washington 98109, and 3118 East Princess Anne Road, Norfolk, Virginia 23504. PTS now operates 30 service centers throughout the United States.

RCA has made its first total product-line change in 28 years, reports **Home Furnishings Daily**. The redesigned line of all solid-state monochrome TV sets also includes higher price tags. Seven basic models in four screen sizes are included in the line, which features dual-MOSFET tuners similar to those used in the color TV line. □

Automatic transistor tester works in-circuit when others can't



B&K PRECISION
520 Dynapeak™
\$150.00

TESTS IN ONLY 9 SECONDS Tests diodes, SCR's and unijunctions, too. Avoids time wasting unsoldering of good transistors that tested bad in circuit and then good out-of-circuit because of erroneous testing. B&K-Precision 520 Dynapeak™ even tests automatically in-circuit with shunts of 10 ohms or 50 mfd. Random lead connection; turn the switch—the rest is automatic: Pulsating audio tone and LED indicates good device; PNP/NPN, Ge/Si shown by LED. No-charts leakage tests. Tests transistor action, not just junction or diode characteristics. Write today!

B&K PRECISION

PRODUCTS OF DYNASCAN

1801 W. Belle Plaine Avenue • Chicago, IL 60613

For More Details Circle (4) on Reply Card

Affordable frequency counter for jobs that have always needed one



MODEL 1801 \$230

With a good autoranging frequency counter you can watch oscillator adjustments, monitor RF and audio frequencies *precisely*, do fast production testing, check critical countdown chains, *calibrate* signal generators, check pull-in range of AFT circuits and CB frequencies accurately. The 1801 is good because its accuracy is typically better than 10PPM; it typically reads 10Hz-60MHz and is *guaranteed* to read 20Hz-40MHz. It's automatic—there's just one control and gate times, decimal points and scalings are automatically selected for best speed and accuracy. And it's fast—the display is refreshed up to 5 times per second.

In stock at your distributor.

B&K PRECISION

PRODUCTS OF DYNASCAN

1801 W. Belle Plaine Avenue Chicago, IL 60613

For More Details Circle (6) on Reply Card

digital IC color generator generates profits that a few tubes never could



Model 1230 \$90.00

Just 1.725" high, 5" wide, 7.750" deep—about the same as a few rectifier or horizontal output tubes. So you carry this convergence generator in your caddy instead of running back to the truck. You may save enough time every day for an extra service call. Much more profitable in that space than tubes. And no sacrifice in quality, because all four patterns—purity, 9x11 dots, 9x11 crosshatch, gated rainbow—are broadcast-stable. No expensive batteries, either. In stock at your distributor or write Dynascan.

B&K PRECISION

PRODUCTS OF DYNASCAN
1801 W. Belle Plaine Ave.
Chicago, IL 60613 • (312) 327-7270

For More Details Circle (5) on Reply Card

Portable Digital Multimeter at an Analog Price

MODEL 280
\$99⁹⁵



Enjoy the benefits of auto-polarity digital read-out plus full overload protection and high-low power ohms for accurate tests in solid-state circuits.

Accuracy better than analog VOM's!

22 RANGES

Reads in decades: AC and DC volts and mA, 1-1000; ohms, 100-10 meg. Resolution: 1mV, 1mA, 0.1ohm.

Accuracy: DC typically $\pm 1\%$ F.S.; AC and ohms typically $\pm 2\%$ F.S. except $\pm 2.5\%$ on highest range. Uses "C" cells. Optional AC adapter/charger.

In stock at your local distributor

B&K PRECISION

PRODUCTS OF DYNASCAN

1801 W. Belle Plaine Avenue Chicago, IL 60613

For More Details Circle (7) on Reply Card

Chassis—RCA CTC58
PHOTOFACT—1365-1

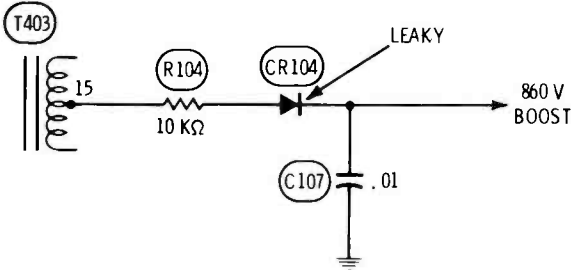

Symptom—Poor gray tracking, and green smear on right of video
Cure—Check CR104 for leakage, and replace it if defective

Chassis—RCA CTC58
PHOTOFACT—1365-1

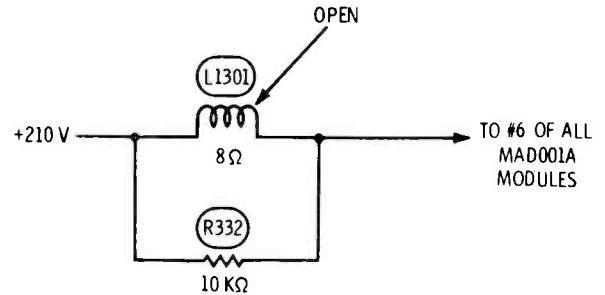

Symptom—Video smear to the right
Cure—Check L1301, and replace it if open

Chassis—RCA CTC51, CTC52 and CTC53
PHOTOFACT—1332-2

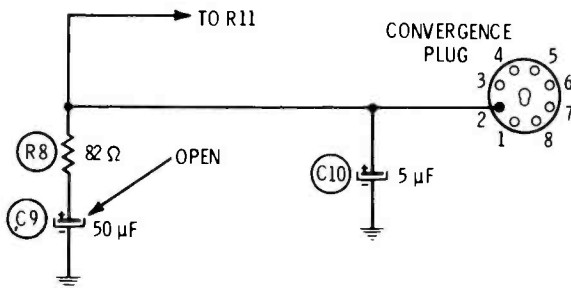

Symptom—Vertical misconvergence of bottom half of picture
Cure—Check C9, and replace it if open

Chassis—RCA CTC48
PHOTOFACT—1300-2

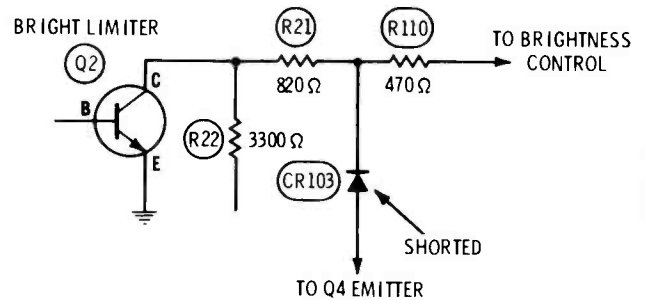

Symptom—No control of brightness
Cure—Check diode CR103, and replace it if shorted

Chassis—RCA CTC48
PHOTOFACT—1300-2

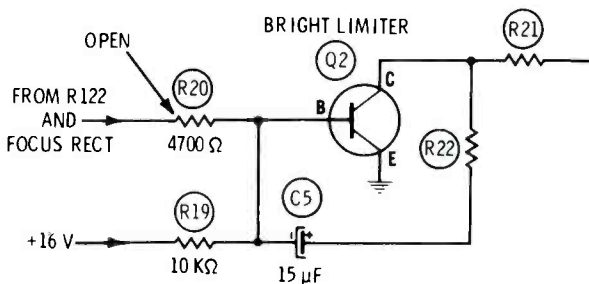

Symptom—Vertical might collapse when brightness is increased
Cure—Check R20, and replace it if open

Chassis—RCA CTC53
PHOTOFACT—1201-1

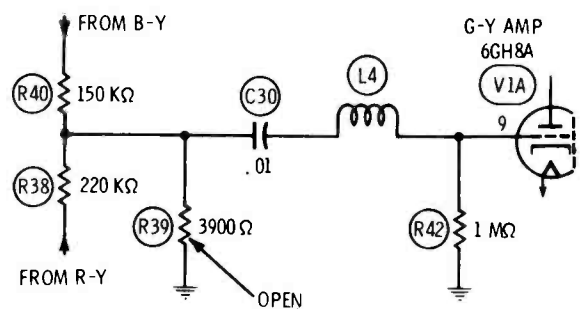

Symptom—No green in color
Cure—Check R39, and replace it if open

The death of a solid-state device needn't complicate your life.

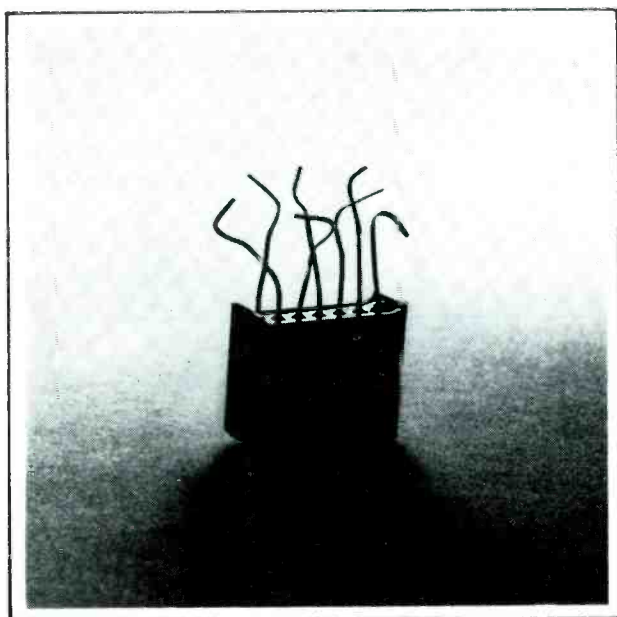

Repair over 126
domestic and imported
brands with
Sylvania modules and IC's.

You take a look at the job and the brand name's Bigston or Kobekiito or Teaberry or Pace.

No problem!

Sylvania replacement modules and IC's fit these brands like a glove. They also fit over 122 other brands, including RCA, Panasonic, Sony—and, of course, Sylvania.

For the vast majority of domestic and imported electronic equipment, all you need is a basic stock of Sylvania ECG™ Semiconductors. And our new Replacement Guide to show you which ones go where.

For a copy, see your Sylvania distributor.

We're helping you make it.

GTE SYLVANIA

FAST

COMPLETE SERVICE ON ALL MAKES OF TV TUNERS

Maximum Time In Shop 24 Hrs.

(Warranty: One Full Year)

(WE SHIP C.O.D.)
YOU PAY SHIPPING
\$9.95

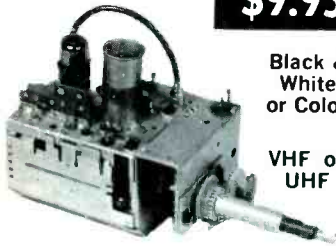

Black & White or Color

VHF or UHF

UV Combo's \$16.50

Price includes all labor and parts except Tubes, Diodes & Transistors. If combo tuner needs only one unit repaired, disassemble and ship only defective unit. Otherwise there will be a charge for a combo tuner. When sending tuners for repair, remove mounting brackets, knobs, indicator dials, remote fine tuning arrangements and remote control drive units.

WE UNCONDITIONALLY GUARANTEE All Tuners FOR ONE FULL YEAR



All tuners are serviced by EXPERTLY TRAINED TECHNICIANS with years of experience in this specialized field. All tuners are ALIGNED TO MANUFACTURER'S SPECIFICATION on crystal controlled equipment and air checked on monitor before shipping to assure that tuner is operating properly.

GEM CITY TUNER SERVICE

Box 6G Dabel Station
1621 Mardon Drive
Dayton, Ohio 45420

troubleshootingtips

Send in your helpful tips—we pay!

A whale in the picture Motorola TS-938 color chassis (Photofact 1299-2)

The lady customer said there was a "whale" on the screen of her new Quasar Motorola. Actually, the vertical sweep covered only about the middle third of the screen, and there were two small black areas (one near each side) that did somewhat resemble the shape of fish.

Because I have been a Quasar nut for years, I smugly snapped in a new VA vertical panel. To my surprise, there was no improvement.

Next, I started testing the DC supply voltages. The 70-volt source measured 74 volts, but that didn't seem serious enough to worry about. Four hours later, I scoped the 70-volt supply and found envelopes of horizontal sweep riding on the DC. Probably that accounted for the extra 4 volts.

After that it was easy to find an open filter capacitor, C808, a 500-microfarad unit off pin 1 of the JA power panel.

Gone are the days of the familiar 60 Hz or 120 Hz hum bars, at least when the receiver is one of the

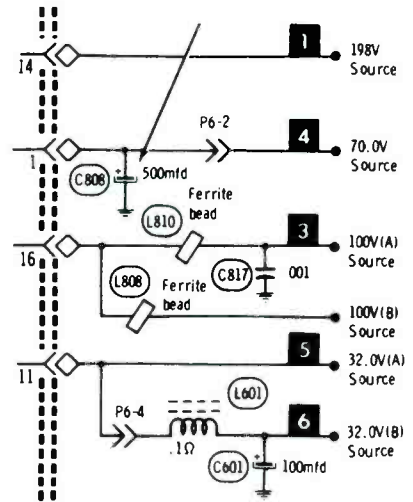

Quasars that have a power supply operating at the horizontal sweep frequency of 15,734 Hz!

Dave Eshbaugh
Clarion, Pennsylvania

Pulsating hum, and open dial lamp Zenith 19EC45 (Photofact 1377-3)

Pulsating hum and raster, and a burned-out pilot lamp were the symptoms. Although there seemed to be no connection between the bulb and the hum, I replaced the lamp first, just so I wouldn't forget it.

Instantly at turn-on, the lamp acted like a flashbulb. It lit with great brilliance, and immediately burned out. My diagnosis changed; perhaps there was a connection between the hum and the lamp.

According to the Photofact, the 6.3-volts for the lamp came from a tap on the secondary of T201. Other taps supplied the four pairs of diode rectifiers, and one ground was common to all.

A quick ohmmeter test showed the secondary winding was not grounded. After the chassis was pulled, I found the ground wire loose in its grounding lug. A good soldering job and a new dial lamp

completed the repairs.

Evidently the total current for the various power supplies went through the bulb (as an alternate ground source), when the ground was open, causing instantaneous failure. I can't explain how the

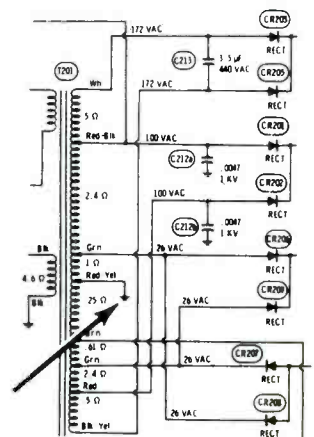

open circuit allowed enough current to produce a raster.

Joseph J. Ruzicka
Seward, Nebraska

reader's exchange

Needed: Schematic of Danelectro Model D5100 amplifier, or address of manufacturer.

Louis P. Foshay
120 Quaker Road
Pomona, New York 10970

Needed: Setup chart for a Heathkit tube tester Model TC-3 to check radio tubes used during 1920s and 1930s. Also need schematic and parts list for Granada stereo Model M8000.

Wayne Kienzle
9500 Sherman Ch. Avenue S.W.
East Sparta, Ohio 44626

Needed: 3KP4 picture tube for Pilot TV. Also need early TV's, antique battery radios, tubes, parts or literature.

Donald O. Patterson
1220 Meigs Street
Augusta, Georgia 30904

Wanted: Jensen speaker Model GP-805 in walnut enclosure, H47"XW28"XD19"; with one 2-1/2-inch and four 3/4-inch horizontal bars across the front, and three vertical 1/2-inch bars between the third and fourth horizontal bars. Would like to buy one or sell mine.

Peter Meek
1788 Miller Avenue
Ann Arbor, Michigan 48103

Needed: Operating instructions for Heath lab scope Model 0-12. Will copy and return.

Max J. Lenke
1471 San Marcos Drive
Hemet, California 92343

Needed: Probe for Hickok VTVM Model 209-A.

William J. Maida
Route 2 Box 471-H
Maitland, Florida 32751

Needed: Information on Belltron CRT rejuvenator, or address of the manufacturer.

C. E. Hope
219 Rugheimer Avenue
North Charleston, South Carolina 29406

Needed: Meter movement for a B&K Model 375 VTVM, part number 321-001-9-002. Will pay reasonable price.

Joe Predovich
1211 W. Williams Circle
Elizabeth City, North Carolina 27909

For Sale or Swap: Sylvania #500 TV sweep generator and Sylvania #501 TV marker generator, brand new and in original cartons.

Certified TV Labs
5519 New Utrecht Avenue
Brooklyn, New York 11219

ROHN® TOWERS



LAST LONGER

Guaranteed
against Rust
because they
are the *only*
Tower Hot Dip
Galvanized
after fabrica-
tion and
Available
Nationally

ROHN® MANUFACTURING

DIVISION OF



P.O. BOX 2000 / PEORIA, ILL. 61601

"Supplying tower needs worldwide
for over 25 years."

For Sale or Trade: Heathkit 1G-57A sweep generator, completely assembled and tested, but never used. Manual included. Will accept the best offer.

Joseph Gubitosa
1918 74th Street
Brooklyn, New York 11204

Needed: Schematic and operating instructions for Mercury in-circuit rectifier tester, Model 600.

Arthur J. Gillman
1912 Basil Drive
St. Louis, Missouri 63125

Needed: Instruction books for Rutherford B7B pulse generator, CEG Data Tape 2700 tape transport, and Ampex TM-1107 tape transport. Also have 50 Crown answering services; will sell for \$30.00 each.

Ed Hansen, Jr.
P.O. Box 2064
Akron, Ohio 44309

Needed: Schematic for Union Carbide Eveready A-C receiver, Model 1, serial number W15290; also need a horn speaker for the receiver.

Steven W. Kemp
54 Willow Avenue
Islip, Long Island, New York 11751

Wanted: Heathkit sweep generator, Model 1G-52; also need Model CA-5 adapter for Hickok tube tester, Model 6000.

Charles C. Saffle
601 Hill View
Hurst, Texas 76053

Needed: Horizontal output transformer for Model CD-3354 Olympic TV, chassis CTC-21, part number TR-34650.

Team Electronics
2304 East Broadway, Box 1512
Bismarck, North Dakota 58501

Needed: Power transformer number 68PO78-1 for Webster tape player Model 2001/2005.

E. E. Nelson
4108 E. Newton
Seattle, Washington 98112

Needed: Schematic for Philco Model 14 console radio; also need schematic for 1946 Ford auto radio manufactured by Zenith.

Electro-Service Company
P.O. Box 681
Appleton, Wisconsin 54911

Needed: Parts list, schematic, and board layout for Accurate Instrument VTVM, Model 152.

Henry Higgins
433 NE 65th Street
Miami, Florida 33138

For Sale: Pyramid CRA-2 capacitor checker in good condition; \$25.00 plus freight.

Jag's Radio & TV
14 Rudolph Road
Forestville, Connecticut 06010

Needed: Schematic for Sun Mark b-w TV, Model SM-12T. Will pay for use, and return.

Bourget Photo & Electronics
Lake Parkway
Webster, Massachusetts 01570

Needed: Schematic or manual for RME-45.

Joseph Gerald Flyr
16281 Mercier Lane
Huntington Beach, California 92647

Needed: Schematic for U.S. Radio & Television AM receiver, Model 31. Also need a NY227 tube, or the address of one who sells old radio tubes.

CW03 K. W. Allen, USN
USNSGA Box 996
FPO New York, New York 09555

Wanted: Hickok signal tracer, Model 156, any condition; also want Simpson Giant VOM, Model 320, any condition.

J. E. Smith Radio Shop
130 Cherry Street
Montezuma, Georgia 31063

Needed: Power transformer for DuMont oscilloscope, Model 304H.

B. W. Vanorsdale
1003 South Henry Avenue
Elkins, West Virginia 26241

Wanted: Old radio text books, Rider's and factory diagram manuals, and magazines from the 1920s and 1930s.

Lawrence Beitman
409 East Chalmers
Champaign, Illinois 61820

Needed: Schematic or any servicing information for Echophone Commercial shortwave receiver.

Tim Galster
3383 Hitchings Road
Nedrow, New York 13120

Needed: Schematic for Craig AM/FM portable radio, Model 1210. Will pay costs.

O. H. Folsom
P.O. Box 338
Vista, California 92083

For Sale or Trade: Antique tubes and Rider's manuals.

Goodwin Radio Shop
Rankin, Illinois 60960

□

Pretty Technicians

The editors are glad to learn of other women actively engaged in the repair of electronic equipment (see page 20 of March Electronic Servicing). Please send us information and pictures of any more lady technicians.

Alice Faye Stewart

Several years ago when Mrs. Stewart's husband was taking a course in radio and television repair, he asked her if she would like to take the course also. He promised to back her in a shop of her own. The idea appealed to Mrs. Stewart, so she enrolled in and completed a two-year course at the George Wallace Technical College in Hanceville, Alabama, and also finished an accounting course. Therefore, she does both repair work and bookkeeping for her own radio/TV shop.

This enterprising lady, a housewife with two daughters, started her business last November in Blountsville, Alabama, where she repairs all kinds of home-entertainment units.

At first, Mrs. Stewart had some problems, because this traditionally has been a man's business. But now she is very enthusiastic about such a "rewarding profession".

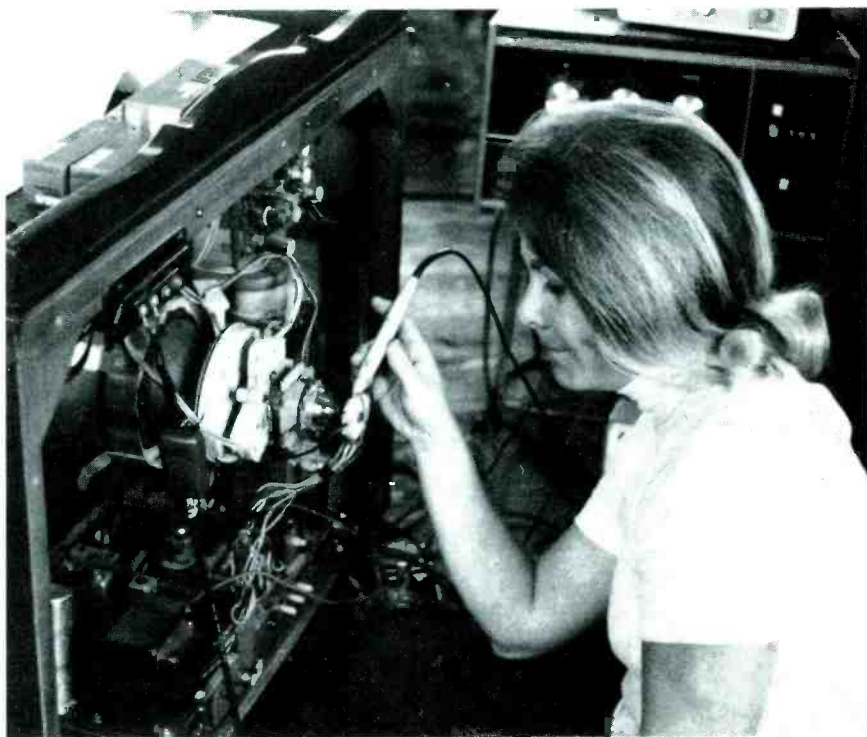

M. Diana Lynn



As a high-school senior in Jacksonville, Florida, Miss Lynn had no idea what profession she should enter. Her senior placement tests indicated an aptitude for mechanical work. Auto mechanics seemed out of the question, so she took courses in mechanical drawing, and electronic drafting. Her interest in electronics deepened, and she enrolled in classes at United Electronic Institute of Louisville, Kentucky.

After graduation from the school, she found employment with the Kimball Piano And Organ Company of Jasper, Indiana. Diana is a technician on a sub-assembly line where electronic organs are manu-

factured, and she repairs printed-circuit boards after they are rejected by inspectors. Sometimes she does troubleshooting using a digital test console, and at other times works on a complete organ.

Diana holds an FCC license, and hopes to pass the CET test someday. In addition she is single, 21 years old, and has many hobbies. She writes that the other technicians (male) are great to work with, and they don't seem to mind a "women's libber" in their midst.

Later, Miss Lynn hopes to learn more about the fascinating field of computers; although she is quite enthusiastic about her present profitable and interesting job. □

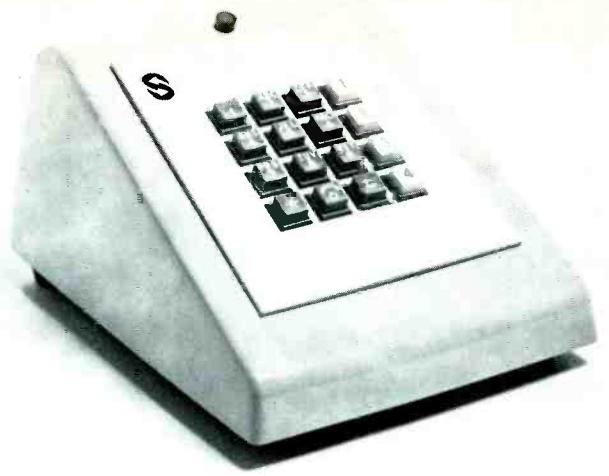

The Speedcall Model 502-A-16 base-station encoder handles selective calling of four receivers. In addition, it supplies pushbutton telephone dialing for mobile-telephone service.

The Quiet World Of Selective Call

Part 1/By Marvin J. Beasley, CET

Another branch of electronics that has grown unnoticed is the type of two-way business-radio communications with the receiver silenced until it is called individually. General facts about the basic systems are given in Part 1. Complete mobile-telephone systems will be analyzed later.

Have you ever listened to a monitor or scanner VHF-band radio receiver and heard strange squawks or beeps before or during the conversation? Well, the audio tones that you heard permit any selective-call radio to ignore all carriers on its channel except the one that has the properly-coded tones. In other words, the radio receiver remains silent until specifically called, just as though those two transceivers were the only ones using that

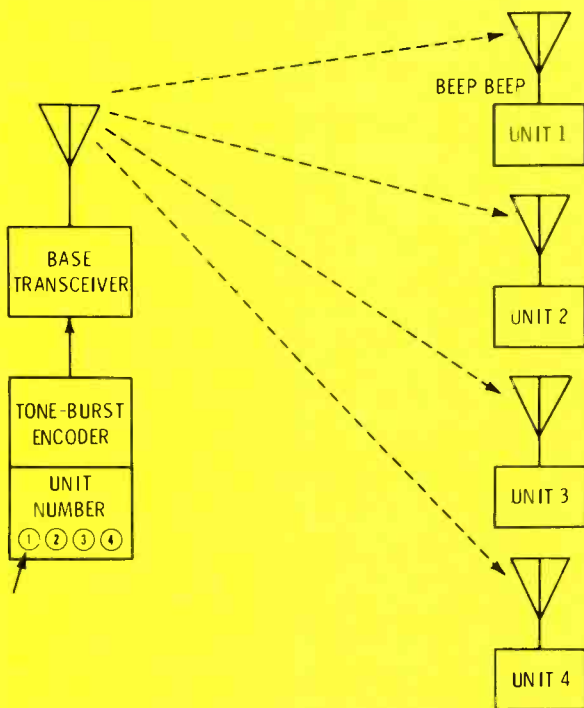

Fig. 1 By use of an encoder at the transmitter and a decoder in each receiver unit, one unit can be called without the message being heard by the others. Most units can be switched so that, when they are called, a light flashes, a horn sounds, or the audio can be heard.

Table 1
Signaling Tones
Used By Reach

Channel Number
And Frequency

CH	HZ
11	2704
12	2612
13	2523
	ETC.
49	725
50	700



This combination encoder/decoder unit is manufactured by Reach Electronics. Other models of similar appearance are for encoding or decoding.

channel.

Perhaps this doesn't seem to be a very important advantage. But, if you have had to listen on a CB radio, for example, to the ripping sound most squelch circuits make when the carrier starts or stops, and to the jumble of dozens of messages intended for someone else, you would appreciate the blessing of radio silence most of the time.

These selective-call radios can be switched so that reception of the correctly-coded carrier will honk a horn, blink a light, unblock the audio, or a combination of such attention-getting methods.

It would be desirable for all systems and brands of equipment to use the same method of signaling, but this is not the case. There are three principle ways of using the audio tones for selective calling.

Tone-Burst Systems

In the most simple and eco-

nomical of the systems, a burst of an audio tone (between 300 Hz and 3000 Hz) is transmitted before the message, to activate the desired receiver. Once triggered, the receiver remains alive until manually reset in preparation for the next call. Before he resets it, the operator will hear all traffic on that channel.

To prevent the audio tones in the voice signals from falsely activating the decoder, the burst of audio must be continued for several seconds, typically from 2 to 5 seconds. Level of the burst is about the same as that of the voices, so voice and signaling do not occur simultaneously.

Encoders and decoders can be added easily to most existing two-way equipment. Figure 1 illustrates one possible use of selective call. The operator at the encoder presses the button for the unit he wants, and only that one of the four responds (with audio, horn, or blinking light). The other three units

hear nothing until they specifically are called. Examples of the audio tones used by Reach Electronics are given in Table 1.

CTCSS Systems

One of the standardized Electronic Industries Association (EIA) systems is the Continuous-Tone Controlled-Squelch System (CTCSS). A single tone of low intensity is broadcast at all times during each call, and the receiver audio is operative only while the tone is there. It is not necessary to reset before another call.

Tone frequencies below 300 Hz (see Table 2) are used to modulate the FM carrier at a low level (about 700 Hz deviation out of the usual ± 5 KHz for 100% modulation), and filters in the receivers are used to minimize the tones so they are not distracting. However, listeners using an unfiltered receiver will hear a distinct rasp or buzz.

Table 3 gives the manufacturers'



RF Communications offers Model RF-1532, a digital decoder for add-on to radio receivers.

Table 2
EIA Tone
Frequencies

HZ
67.0
71.9
77.0
ETC.
241.8
250.3

Table 4
Encoder-Decoder
Manufacturers

Reach Electronics, Inc.
Box 308A
Lexington, Nebr. 68850

Bramco Controls Division
College and South Streets
Piqua, Ohio 45356

Vega
9900 Baldwin Place
El Monte, Calif. 91731

Fantron Corporation
4023 W. 30th St.
Little Rock, Ark. 72204

Communications Specialist, Inc.
11409 Chandler Blvd.
North Hollywood, Calif. 91601

Alpha Electronic Services
8431 Monroe Ave.
Stanton, Calif. 90680

Secode Electronics
908 Dragon St.
Dallas, Texas 75207

Speedcall Corp.
2020 National Ave.
Hayward, Calif. 94545

Table 3 CTCSS System Names

Sub-Audible Tone System	(Generic Name)
Tone-Coded Squelch or TCS	(Generic Name)
Channel Guard	General Electric
Private Line	Motorola
Quiet Channel	RCA
UniCall	Aerotron
Call Guard	E. F. Johnson
TCS	RF Communications
Private Channel	Standard Communications

trade names for units using the CTCSS system. These are compatible, and the equipment can be intermixed.

A maximum of 33 companies can operate on the same channel under the EIA CTCSS system without hearing each other.

To prevent interference with other users, it's a legal requirement for the operator to monitor the channel before transmitting. Some equipment switches to monitor when the microphone is removed from the hangar. Base microphones have a split bar for press-to-talk operation; the monitor bar must be pressed before the transmit bar can be used.

Two-Tone Sequential

The most-often-used system for paging receivers and add-on decoders for mobile two-way units, is the Two-Tone Sequential (TTS). The advantage is the large number of codes that can be developed with a relatively-small number of audio frequencies.

The TTS encoder generates two audio tones in rapid succession,

with a short time of a few milliseconds between them. Only if the frequencies are correct and in the right sequence does the decoder in the receiver respond by activating the audio. Further, the tones must be exactly on frequency and have the proper duration (2 to 5 seconds). One exception is the Reach Electronics system which requires a total time of only 250 milliseconds.

Many of the TTS encoders and decoders are compatible despite small variations between them.

High-Capacity Two-Tone Sequential

Motorola originated the High-Capacity and Ultra-High-Capacity systems which have become standards of the industry. They are extensions of the TTS, with thousands of codes available. The code designations are somewhat hard to decipher, as they have a letter and three numbers, and three tables are required to determine the code frequencies.

Additional Information

Table 4 lists the names and

addresses of eight manufacturers of encoders and decoders for addition to normal two-way radio transceivers. Usually they are responsive to inquiries from people with electronic sales and service businesses.

If you have ever had experience with tuned circuits that are resonant in the audio frequencies, you probably know most tune too broadly and drift too much for use in selective calling systems, where the frequencies are so close together.

That's why the original models of encoders and decoders used tuned reeds to obtain the necessary selectivity and stability. The "Q" of mechanical resonant circuits (such as reeds) can be made extremely high, and the size is small, measuring perhaps an inch by two inches.

At this time, electronic filters have replaced reeds in about 50% of the units, and it's expected that the use of reeds will decrease eventually to zero. More information about both reeds and electronic filters will be included in future articles. □

Computer-like accuracy in pricing!

That's the way Tech's Guide works! Like a computer. Tech's Guide contains mountainous quantities of work/time facts (7 years of "feed-in")

...you extract the job pricing you want almost as easily as pressing a button. That's errorless pricing in the 19 major categories of repair...true and proper balance between cost and work performed. You can bank on it! Pricing calculator adjusts to any area in U.S. in seconds. **Tech's Guide** is in

a professional, hard-use cover, 6-ring steel binding, fast-tab design, 7½ x 9½ size fits in the tool box...ready for immediate use. Thousands of shops, coast to coast, have proved its value. **Order yours** with the coupon, enclose check or money order. All orders filled same day.

tv & radio
tech's guide to pricing

\$18⁰⁰
per issue,
postpaid.

(Nebr. residents add city and state sales tax)

At several times the price.. it's really low-cost, cool-temper insurance in customer relations.

the guide with a brain builds trust.

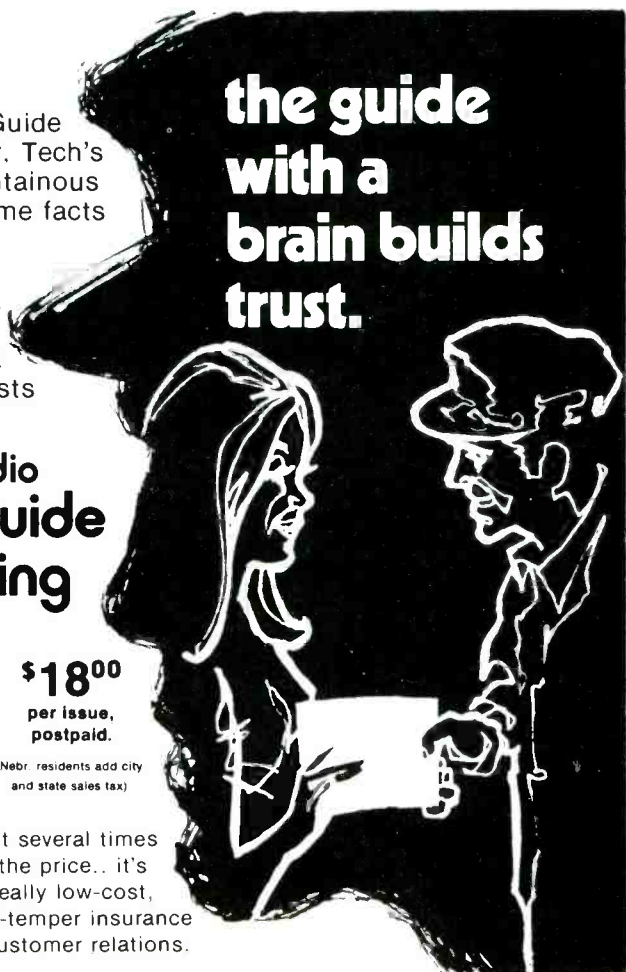
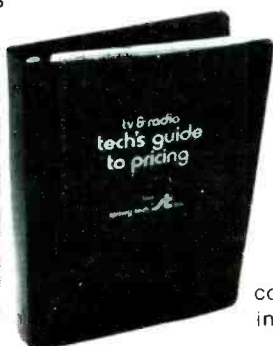

sperry tech inc.
P.O. Box 5234
Lincoln, NE. 68505

More information please.
 My check or money order enclosed.

NAME _____
COMPANY _____
ADDRESS _____
CITY _____ STATE _____ ZIP _____

For More Details Circle (10) on Reply Card

RCA

Service Data



**Accurate
Information
Easy To
Locate**

**A Well
Organized
Complete
Technical
Library**

**Previous
Year's
Service Data
Available in
Complete
Year's File.**

**A Necessity
To Profitable
Service**

**A
Complete
RCA
Service Data
File
For Each
Technician
Saves Time

Order
Today**

QUANTITY

_____ "File—1975" Service Data Subscription including 2 binders \$31.95

_____ "File—1975" Service Data subscription \$24.95

_____ Binders available separately—\$3.50 each

_____ Previous years Data (\$24.95 per set) File: 74 , 73 , 72 , 71 ,
70 , 69 , 68 , 67 ,
66 , 65

Amount enclosed: \$ _____

NAME _____

(Please Print)

STREET ADDRESS _____

CITY _____ STATE _____ ZIP CODE _____

- Your order will be processed promptly upon receipt of your check or money order in the amount indicated above.

SEND TO: RCA CONSUMER ELECTRONICS
600 N. Sherman Drive, Indianapolis, Ind. 46201

ATTN: Technical Publications, 1-450 (Or Contact Your Distributor)

Note: Prices Subject To Change Without Notice
7523-1

Postpaid U.S.A. only



A PRACTICAL BOOKKEEPING SYSTEM

By Joseph Arkin, C.P.A.

Does your present bookkeeping system warn you of dangerous tendencies toward excessive inventory or insufficient cash flow? Can it easily supply the facts for net-worth or return-on-investment reports? If any of your answers is "No", take advantage of the many valuable suggestions for a complete and flexible system.

Accurate and complete business records are essential for realistic labor pricing, providing valuable profit-and-loss information, and for satisfying the requirements of the Internal Revenue Service.

Federal laws do not dictate any specific system of bookkeeping. However, the system you use must supply permanent and complete records that clearly show income, expenses, credits, employee information, and many other facts. The bookkeeping system we'll describe satisfies these requirements; it's called double-entry bookkeeping.

Double-Entry Bookkeeping

Bookkeeping by the double-entry method has the large advantage of being self-testing for accuracy. Entries are made in two places, and at the time of accounting, two final figures must be equal. If not, an item has been incorrectly entered, or a mathematical mistake has been made.

Journals and ledgers

Transactions are entered first in

a **journal** (book of original entry), and then summary totals of the transactions (usually figured monthly) are posted (transferred) to the appropriate **ledger** accounts.

Ledger accounts are of several types, such as: income, expense, asset, liability, and net worth. Income and expense accounts are closed at the end of the accounting period, whereas asset and liability or net worth accounts are maintained on a permanent basis.

At the end of each accounting period, financial statements easily can be derived from the accounts. These statements normally consist of the income statement, and the balance sheet. The income statement reflects the profit-and-loss for one year only, while the balance sheet shows the net financial worth (sometimes called proprietorship or capital) that has accumulated from all the years of operation.

Single-entry bookkeeping

A more-simple system is single-entry bookkeeping, which records only the flow of cash, receivables,

and payables. It usually concentrates only on the profit-and-loss statement, and ignores the importance of the balance sheet. Sometimes this permits large errors to remain undetected, and that can seriously distort the income figures. The double-entry system prevents most such errors.

Cash Or Accrual?

The two most popular accounting methods are the **cash** receipts and disbursements, or the **accrual** receipts and disbursements.

When using the cash method, you are required to include in the gross total income all items of income **actually received** during the year. (Property and services must be listed at their fair market value.)

With the accrual method, all items of income are included in gross income **when earned**, even though payment might be received in another tax year. All events fixing the right to receive the income must have occurred, and you must be able to determine the amount with reasonable accuracy.

Hybrid method

A combination of cash and accrual methods will be permitted by the Internal Revenue Service, if the combination (known as a hybrid method) clearly reflects income, and is applied consistently. However, the treatment of certain items of income and expense (long-term contracts, installment sales, depreciation, etc.) must comply with specific requirements of the tax

laws.

Most service shops probably should use the cash method. If you want to use the hybrid method, better consult with an authority in the field of bookkeeping.

Note: Business and personal tax returns can use different methods of accounting. For example, you can employ the accrual method for your business, and still use the cash basis for your personal return.

Accrual for sales

The accrual method is mandatory for any establishment selling merchandise, because profit-and-loss is affected by the inventory of merchandise.

The Best Of Both Systems

A true accrual set of books would entail having a sales register with an accompanying accounts-receivable ledger, and a purchase book

Transaction Number	Date	Details		
# 1	Jan. 2, 1975	Daily receipts	\$ 404	new merchandise
			82	repairs & supplies
			16	sales tax collected
# 2	Jan. 3, 1975	Paid Tim Hawlin \$ 22 for store repair.		
# 3		Bought merchandise from Jones Distributors, \$ 808, bought supplies from Smith & Co. \$ 210.		
# 4		Daily receipts	\$ 201	new merchandise
			46	repairs & supplies
			8	sales tax collected
# 5	Jan. 4, 1975	Paid Jones Distributors \$ 482 for merchandise purchased in December.		
# 6		Daily receipts	\$ 200	new merchandise
			41	repairs & supplies
			8	sales tax collected
# 7	Jan. 5, 1975	Paid Belmont Press for advertising circulars, \$ 28.		
# 8		Paid \$ 606 to Gale Inc. for merchandise purchased in December.		
# 9		Daily Receipts	\$ 127	new merchandise
			38	repairs & supplies
			6	sales tax collected
#10	Jan. 6, 1975	Paid \$ 220 to Standard Realty, Jan. rent.		
#11		Daily receipts	\$ 150	new merchandise
			61	repairs & supplies
			6	sales tax collected
#12	Jan. 7, 1975	Paid \$ 400 COD shipment, Gale Wholesalers for merchandise.		
#13		Daily receipts	\$ 486	new merchandise
			62	repairs & supplies
			19	sales tax collected
#14		Paid IRS for December social security and withholding taxes, \$ 88.		
#15		Paid Bill Adams for week's wages, \$ 98, after deducting \$ 7 FICA tax and \$ 15 withholding.		

Fig. 1 These 15 transactions are used to illustrate typical business activities that must be recorded in the proper journal.

Cash Receipts Journal, Month of January, 1975

CR Page 1

	Deposit to Bank	Cash Collected	Sale of Mdse.	Income-Repairs or Supplies	Sales Tax Collected
(1) Jan. 2 Monday		502	404	82	16
(4) Jan. 3 Tuesday		255	201	46	8
(6) Jan. 4 Wednesday	1006	249	200	41	8
(9) Jan. 5 Thursday		171	127	38	6
(11) Jan. 6 Friday		217	150	61	6
(13) Jan. 7 Saturday	955	567	486	62	19
Totals (end of the month)	7546	7546	6088	1212	246

Summary

	Debit	Credits
(1) Cash in Bank	7546	
(21) Sale of Mdse.		6088
(22) Income—Repairs or Supplies		1212
(23) Sales Taxes		246
	7546	7546

Fig. 2 All records of cash coming in are recorded in the Cash-Receipts Journal. At the end of each month, a summary is posted in the Ledger. The numbers in parenthesis are for identification only.

Cash Disbursements Journal, Month of January, 1975

CD Page 1

	Check Paid	Mdse.	Parts or Supplies	Store Expenses	Net Wages
(2) Jan. 3 Tim Hawlin	2			22	
(5) Jan. 4 Jones Distrib.	482	482			
(7) Jan. 5 Belmont Press	28 (Adv)				
(8) Jan. 5 Gale Inc.	606	606			
(10) Jan. 6 Standard Realty	220 (Rent)				
(12) Jan. 7 Gale Wholesalers	400	400			
(14) Jan. 7 IRS	88	(60WT/28SS)			
(15) Jan. 7 Bill Adams	98				98
Totals (end of the month)	3253	2060	297	168	392

Note: No entry was made for transaction #3. Purchases won't be reflected at this time.

Summary

	Debits	Credit
(24) Merchandise	2060	
(25) Parts or Supplies	297	
(26) Store Expenses	168	
(28) Net Wages	392	
(29) Advertising	28	
(30) Rent	220	
(14) Withholding Tax	60	
(14) FICA Tax	28	
(1) Cash in Bank		3253
	3253	3253

Fig. 3 Cash paid out is listed in the Cash-Disbursements Journal, and a summary is posted in the Ledger each month.

cartoon corner



"I'd have called earlier, but my husband let all his friends have a crack at it first."



"They've gone too far with miniaturization ...I can't find that all-band transceiver I was working on!"



"I told you my electrical training was limited to wiring toasters."

Payroll Book
January, 1975

PR Page 1

	M	T	W	T	F	S	Gross Pay	FICA (SS)	State or Local	Federal With'd.	Net Payroll
Jan. 7	8	8	8	8	8	8	120	7		15	98
Jan. 14	8	8	8	8	8	8	120	7		15	98
Jan. 21	8	8	8	8	8	8	120	7		15	98
Jan. 28	8	8	8	8	8	8	120	7		15	98
							480	28		60	392

Fig. 4 Data about the hours, pay, and deductions of employees are recorded in the Payroll Book. Individual payroll cards are convenient, if there are several employees.

with an accompanying accounts-payable ledger. Obviously, maintaining such an elaborate system is too cumbersome and time-consuming for most electronic shops.

Instead, we will outline a system that will comply with the rules of the IRS, but is simple to operate. It's done by a set of double-entry books that are kept on a cash basis all during the year. Then at year end, you convert it to an accrual system by simply adjusting for the total amount the customers owe you for parts and labor.

These four books of account are required:

- cash-receipts journal;
- cash-disbursements journal;
- payroll book; and
- general ledger.

All transactions are entered first in the appropriate one of the three journals (books), and are transferred later to the general ledger.

Figure 1 shows 15 transactions that will be used as examples. The end-of-month totals reflect additional entries **assumed** to have taken place. Of course, the 15 items (numbered for identification when they appear later) never appear on the books in a single list of this kind. Instead, they are posted in

the proper one of the three journals (Figures 2, 3, and 4).

At the end of each month, all items from the three books of original entry should be posted to the general ledger. Aside from the necessary bookkeeping functions, the general ledger provides a rapid means of comparison with previous years, it shows the date and figures of events (such as the purchase of test equipment), and it provides a month-by-month summary of operations.

A general ledger seems complicated, but just remember it is only a number of "T" accounts, arranged in this form:

Name Of Account	
Debit Side	Credit Side

Whether a debit or credit increases or decreases the amount of the account depends on the classification of that account, as shown in Figure 5. The reasons for this are not easy to explain, but they have to do with the relationship of the accounts to proprietorship, or net worth.

For double entry, each transaction must be listed twice in the general ledger, as a debit under one account, and as a credit under another. Of course for simplicity, similar transactions often are combined as shown in the journal summaries. Most transactions will be between an "asset" and a "liability", and this indicates whether a debit or credit should be

Any Asset Account																			
Debit increases (+)	Credit decreases (-)																		
Any Expense Account																			
Debit increases (+)	Credit decreases (-)																		
Any Liability Account																			
Debit decreases (-)	Credit increases (+)																		
Any Income Account																			
Debit decreases (-)	Credit Increases (+)																		
Any Capital Account																			
Debit decreases (-)	Credit increases (+)																		
<table border="0" style="width: 100%; border-collapse: collapse;"> <tr> <td style="text-align: center;">Assets</td> <td style="text-align: center;">=</td> <td style="text-align: center;">Liabilities</td> <td style="text-align: center;">+</td> <td style="text-align: center;">Capital</td> <td style="text-align: center;">+</td> <td style="text-align: center;">Income</td> <td style="text-align: center;">-</td> <td style="text-align: center;">Cost and Expense</td> </tr> <tr> <td style="text-align: center;">+ -</td> <td></td> <td style="text-align: center;">- +</td> <td></td> <td style="text-align: center;">- +</td> <td></td> <td style="text-align: center;">- +</td> <td></td> <td style="text-align: center;">+ -</td> </tr> </table>		Assets	=	Liabilities	+	Capital	+	Income	-	Cost and Expense	+ -		- +		- +		- +		+ -
Assets	=	Liabilities	+	Capital	+	Income	-	Cost and Expense											
+ -		- +		- +		- +		+ -											

Fig. 5 Whether an entry in the ledger is debited or credited depends on the kind of account. With assets and expense accounts, debits increase and credits decrease the amount. Conversely, with liabilities, income, and net worth (capital or proprietorship), debits decrease and credits increase the amount. The "T" format also can show the old classic definition of: Assets = Liabilities + Net Worth + Income - Cost and Expense.

Summary

	Debit	Credits
(27) Gross payroll—wages	480	
(14) FICA Tax		28
(14) Federal Withholding Tax		60
(28) Net Payroll		392
	480	480

shown. If two "asset" accounts are affected, one must be debited (increased) and the other credited (decreased). For example, you might sell a tube for cash. Cash must be debited because it is increased, and inventory must be credited because it is decreased.

The General Ledger

At the end of each month, the debits and credits of the cash-receipts journal, cash-disbursements journal, and payroll book should be posted to the proper accounts in the general ledger (Figure 6).

Also, at the same time, all of the debits are totalled and the credits are added. The two answers are called a "trial balance". When the amounts are equal, it's assumed that all items are posted correctly. This is one of the advantages of double entry. However, the totals will balance mathematically if some items were posted to the **wrong** accounts, so care must be used.

How many accounts?

While we only gave a few examples, an actual business would be expected to have many more accounts in the ledger. There is no recommended number of accounts; use as few or as many as required by your own business activity.

The Actual Bookkeeping

You can have your business bookkeeping done in several different ways. You can pay an accountant to do all the work. This is called a "write-up" and is the most costly. Another alternate is for you

1975 GENERAL LEDGER

Cash in Bank					
Jan. 1 Balance	(OL)	982	Jan. 31	(1-CD1)	3253
Jan. 31	(1-CR1)	7546			
Equipment					
Jan. 1 Balance (Cost)	(OL)	2014			
Reserve for Depreciation					
			Jan. 1 accumulated	(OL)	566
Merchandise Inventory					
Jan. 1	(OL)	3605			
Taxes Payable—FICA					
Jan. 31	(14-CD1)	28	Jan. 1	(OL)	24
			Jan. 31	(14-PR1)	28
Taxes Payable—Federal WT					
Jan. 31	(14-CD1)	60	Jan. 1	(OL)	60
			Jan. 31	(14-PR1)	60
William Boyd, Capital					
			Jan. 1	(OL)	5169
Sale of Merchandise					
			Jan. 31	(21-CR1)	6088
Income—Repairs or Supplies					
			Jan. 31	(22-CR1)	1212
Sales Taxes Payable					
			Jan. 31	(23-CR1)	246
Purchases—Merchandise					
Jan. 31	(24-CD1)	2060	Jan. 1	(24-OL)	1082
Purchases—Parts or Supplies					
Jan. 31	(25-CD1)	297			
Store Expenses					
Jan. 31	(26-CD1)	168			
Wages					
Jan. 31	(27-PR1)	480			
Net Wages					
Jan. 31	(28-CD1)	392	Jan. 31	(28-PR1)	392
Advertising					
Jan. 31	(29-CD1)	28			
Rent					
Jan. 31	(30-CD1)	220			
Deposits as Security					
Jan. 1	(OL)	300			

Fig. 6 At the end of each month, summaries of similar transactions from the three journals are posted to the proper accounts in the Ledger. The numbers in parenthesis identify the journal from which the figure came. For example, OL means "old ledger", 12-CD1 is "item 12 of Cash-Disbursements Journal, page 1", and so on.

or an employee to maintain the journals, and call an accountant to post items in the ledger (termed a "general-ledger write-up"). Or you can do all of the work as outlined, and have your accountant only check your books (an audit).

Of course, other allied duties must be performed as well. These include government reports, tax returns, and reconciliation of the bank statement.

Changing From Cash To Accrual

Your bookkeeping can be the simple "cash" type, if you have no inventory of parts or merchandise, and all your income is from cash sales of labor and parts. However, if you have either sales merchandise

or component parts in inventory, the IRS insists that your business tax return account for it with "accrual" bookkeeping.

Unfortunately, a perpetual accrual system is complicated and costly to maintain. An excellent solution is to maintain your books as a cash system, then at the end of the year, convert it to accrual.

Profit-And-Loss Statement

Change to accrual and figure your yearly profit-and-loss statement this way: add the total of uncollected receivables (money owed to you for parts, merchandise or labor) to the total cash income for the year. **This is your total gross income.**

Expenses are calculated in a

similar way: add the total expenses to the opening inventory; add the unpaid payables (money you owe); and subtract the closing inventory. **This figure is the total expense.**

To obtain the net income (profit-and-loss figure) for the year, just **subtract total expense from the gross income.**

Net Worth

Net worth of the business can be obtained by subtracting the total of liability and income accounts from the total of the assets and expense accounts (Figure 7).

Return-On-Investment

One vital measure of the health of a business is called "return-on-investment". In its most-simple form, the total investment (cash, equipment, etc.) is divided into the yearly net income (profit), with the answer expressed as a percentage. For example, a profit of \$1,000 and a total investment of \$5,000 would be a return-on-investment of 20%.

Computation of return-on-investment with proprietorships (non-corporations) sometimes is complicated by cash advances to the owner, and any accumulated net worth. Ask your accountant for help in such cases.

Comments

A good bookkeeping system can be extremely valuable in exposing potential business problems while there's still time to correct them. In addition, the same system can please the IRS.

There is no way you can establish service-labor prices that are high enough to be profitable, and low enough to be competitive, without accurately knowing your costs.

If you are a working proprietor, you are entitled to a salary for work performed plus a fair profit from the money you have invested. After all, the money could have been invested in a savings account where it would bring in around 6% interest. Therefore, a return-on-investment of less than 6% means you are losing money.

Whether you do the bookkeeping yourself or pay an accountant to do it, we urge you to keep adequate, accurate records, and take advantage of the valuable benefits that the facts from the ledgers can give you. □

BALANCE SHEET A	
DEBITS	CREDITS
ASSETS	LIABILITIES
Cash	Notes Payable
Inventory	Accounts payable—vendor
Accounts receivable	Sales taxes payable
Pre-paid insurance	Payroll taxes payable
Trucks and test equipment	Advances from partners
Advances to partners	
EXPENSE ACCOUNTS	INCOME
Merchandise purchased	Labor sales
Parts and supplies bought	Component-parts sales
Wages	Merchandise sales
Rent and utilities	Depreciation of equipment
Advertising	
	NET WORTH

BALANCE SHEET B			
Cash in bank	982	Owed for	
Equipment	2014	merchandise	1082
Inventory	3605	Reserve for	
Deposits as secur.	300	equip deprec	566
		Payroll taxes owed	84
			<u>1732</u>
	<u>6901</u>		
	6901		
	-1732		
NET WORTH	<u>5169</u>		

Fig. 7 The "T" form of debits and credits also applies to the Balance Sheet, used to find Net Worth. Illustration "A" shows most of the items necessary for the calculation, while "B" is an example using figures.

SERVICING MODULAR COLOR

Part 6/By Charles D. Simmons

Some unique features of the Quasar TS941 color chassis include a cadmium-sulfide cell in a circuit that increases brightness, contrast, and color saturation when the room lighting becomes brighter, and a 20-volt power supply developed by rectification of square waves from the horizontal driver transistor. Regulation of this supply also regulates the horizontal drive.

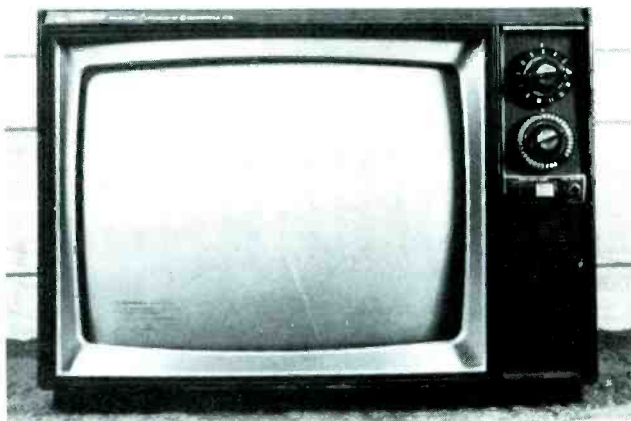

Figure 1. The only front panel controls of this Quasar color portable are: VHF channel selector with concentric fine tuning; UHF knob detented for alternate channels; pushbutton for Super-Insta-Matic pre-set operation; lens covering the cell that's used for sensing ambient light; and a volume control with off/on switch.

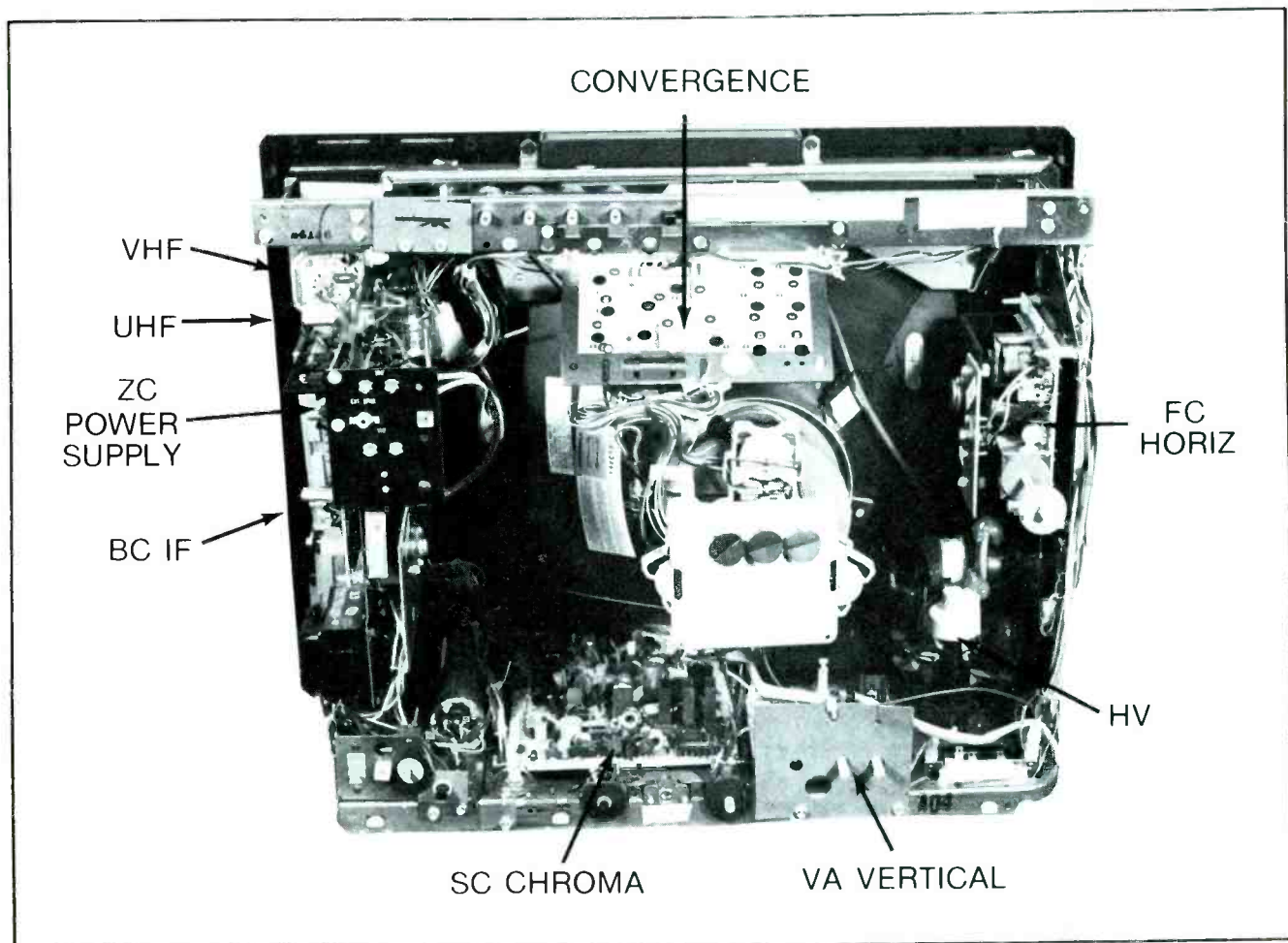

Figure 2. Removal of the large one-piece plastic back which covers five sides of the receiver makes accessible

virtually all of the plug-in panels, wiring, tuners and other components.

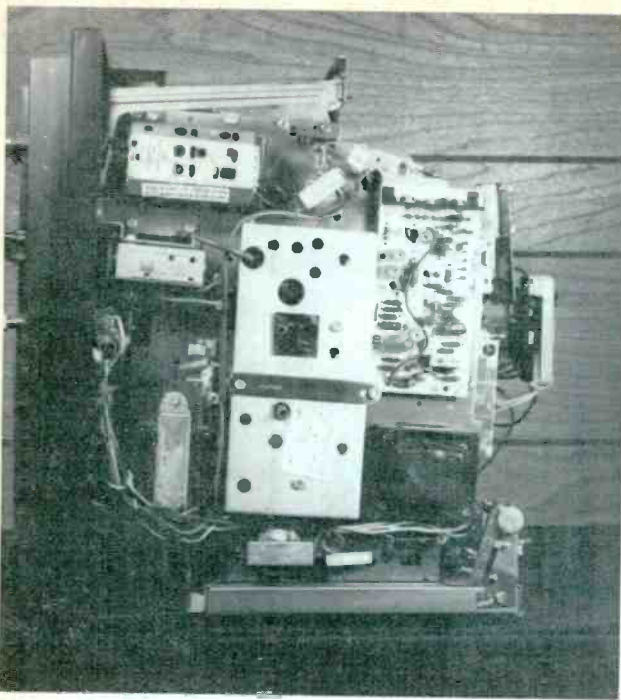

Figure 3. This view of the tuner side shows the two tuners (upper left), L804 filter choke below the tuners, shielded IF panel in the center (with black hold-down strap), CRT-heater transformer below the IF's, the ZC power-supply panel (with SCR's for regulation) at the upper right, and L803 (large, black input-power choke) at the lower right.

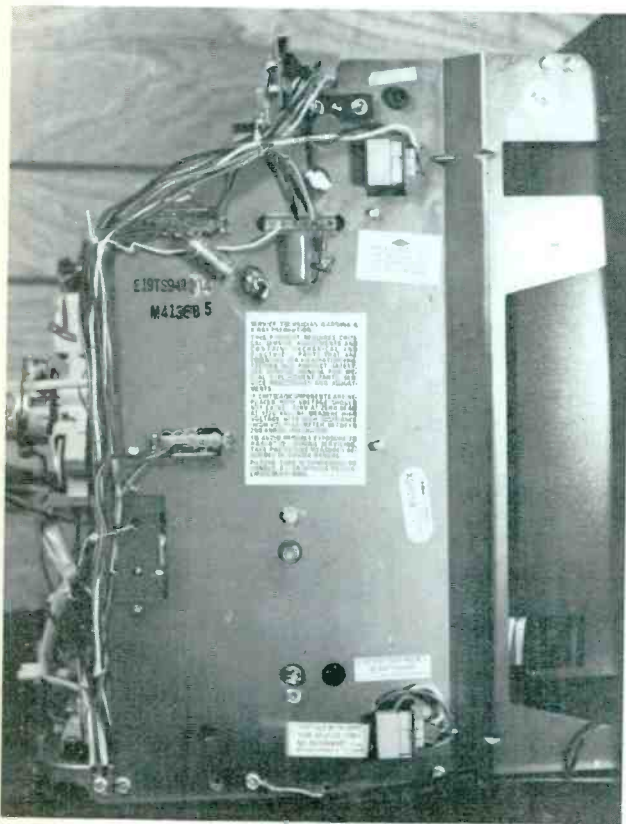

Figure 4. The side panel, which functions as mounting and shield for the HV components, has F802 (700-milli-ampere B+ fuse) and D501 damper diode mounted near the top, and R801 (1.2-ampere B+ fuse) near the lower right corner. Don't overlook these components.



Figure 5. If minor repairs or contact cleaning of the VHF tuner ever becomes necessary, the shield cover slips off easily.

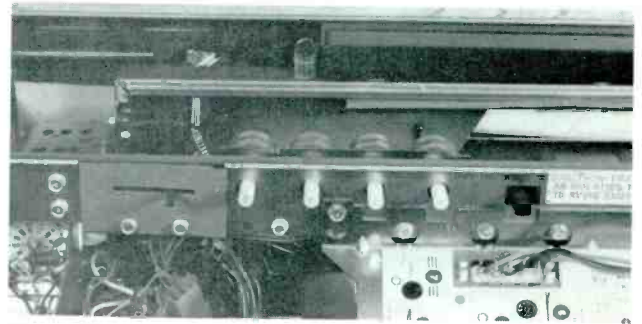

Figure 6. Along the top rail at the back of the set are the manual and pre-set controls. At the left is the sliding-type manual picture control (R103), second are the manual and pre-set brightness controls, next the manual and pre-set hue controls, then the manual and pre-set color controls, and finally the video peaking and the pre-set picture control. The pre-set controls can be adjusted through the hollow shafts of the manual controls. Notice there is no "contrast" control. The picture control regulates contrast, but it also affects the color saturation; there are two functions.

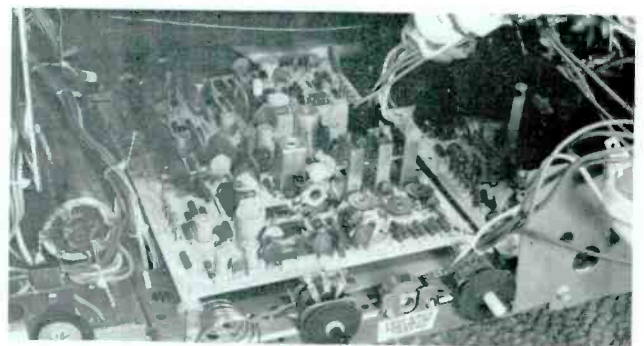

Figure 7. Largest and most-complex of the panels is the SC color/video board. It contains 2 IC's, 15 transistors (including 3 power transistors used as red, green, and blue outputs), all of the chroma circuit, one video stage, and most of the Automatic Brightness Limiting (ABL) wiring. Control of hue, peaking, color saturation, and contrast functions is accomplished by varying DC voltages applied to the IC. That's very efficient, but frustrating when you want to understand the circuit action. Matrixing of video and chroma signals is done inside IC2.

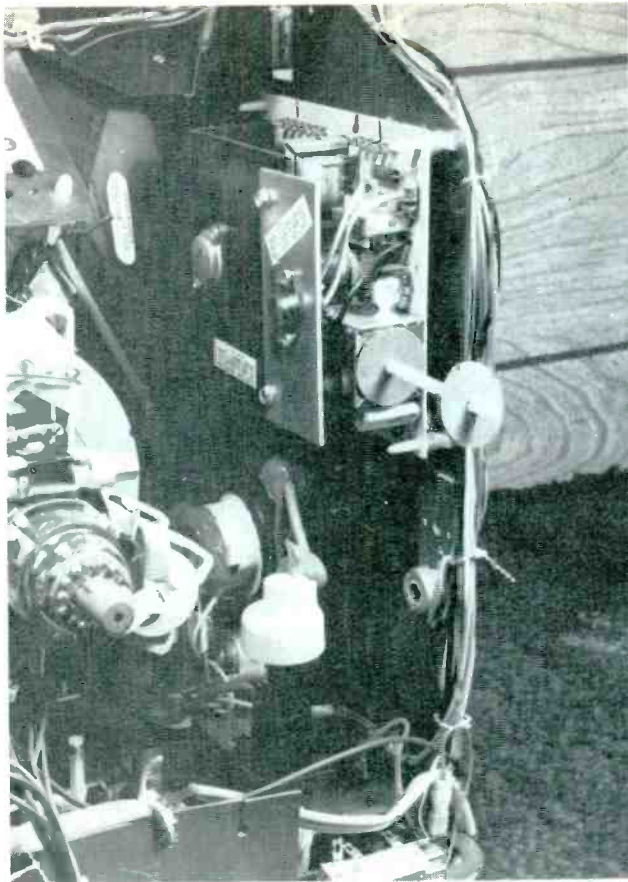

Figure 8. Horizontal panel FC is attached to the side panel above the flyback transformer and solid-state high-voltage rectifier (under white cap). The shaft at the rear of the panel is for adjustment of the horizontal hold. Both the driver and output transistors are plugged into sockets, and can be removed easily for testing.

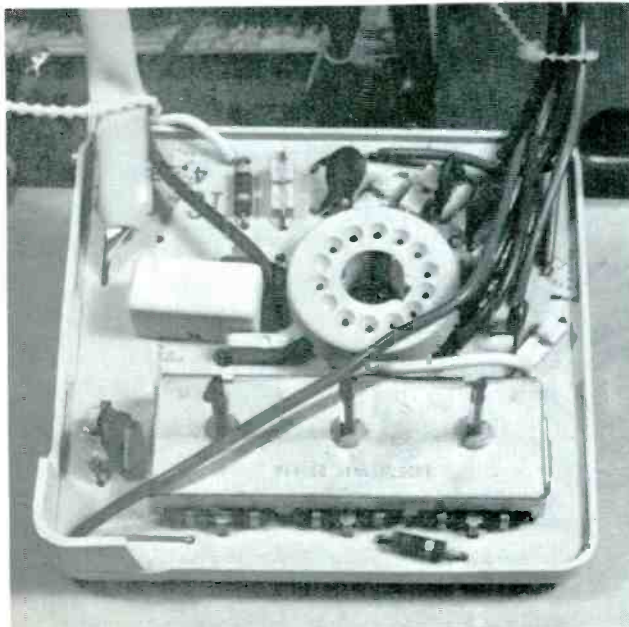

Figure 9. The CRT socket assembly contains three screen-grid (G2) controls, protective resistors, and spark gaps. A large, insulated ground strap connects to the chassis.

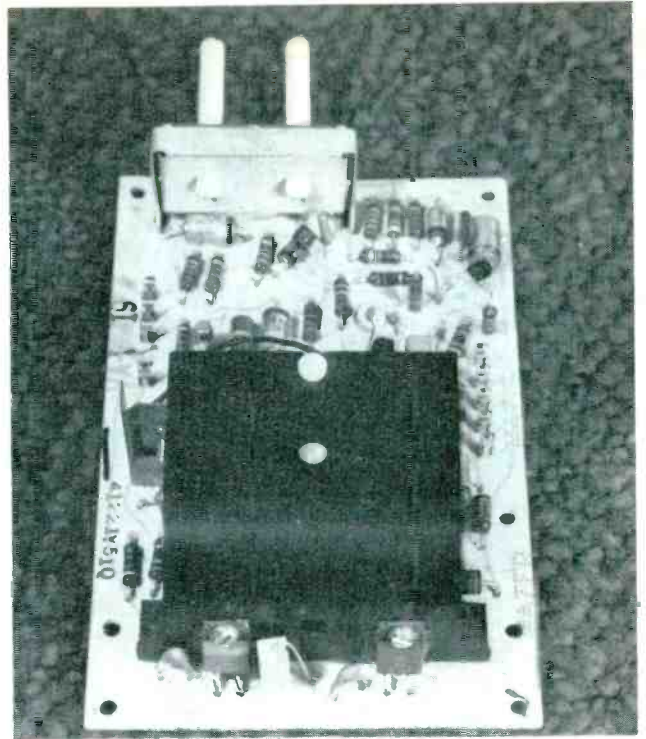

Figure 10. Panel VA contains all of the vertical-sweep components (except for the vertical-hold control). The complementary-symmetry output transistors are mounted on a large heat sink at the front of the panel, and they are capacity-coupled to the yoke windings.

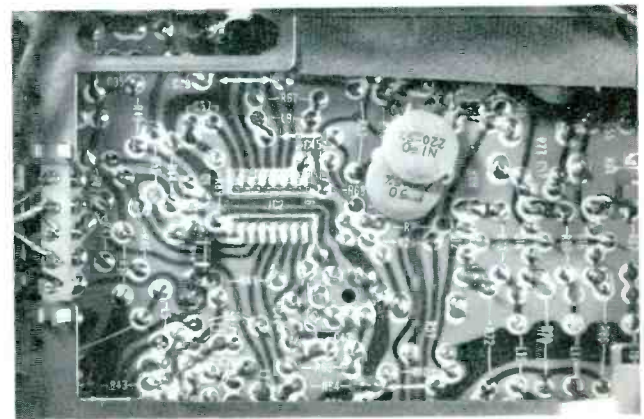
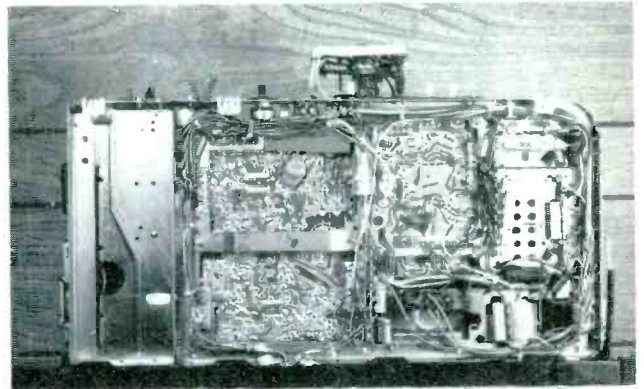

Figure 11. Most of the wiring of the mother chassis, as well as that of the panels at the bottom, is accessible when the cabinet back is removed. Locations of the components are marked on the panels.

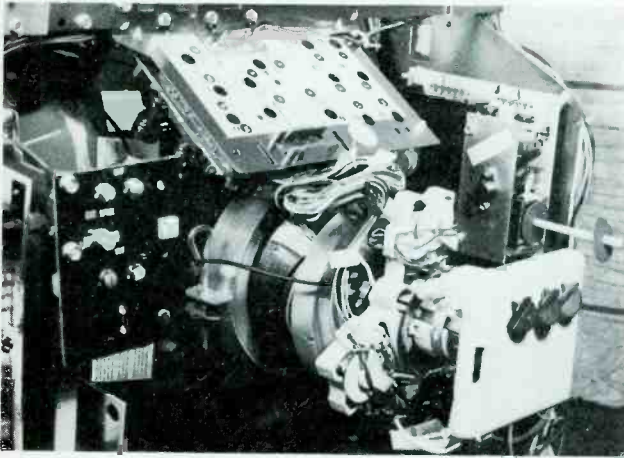

Figure 12. Dynamic-convergence components are on a slanted shelf above the picture tube; center-convergence and purity assemblies are mounted on the neck of the CRT in the conventional way. There is no set-up switch. So, for a quick touch-up of screen color, turn down completely the color intensity, adjust the 3 screen controls (on CRT socket) for good gray at **low** brightness, and the 3 video-drive controls (on the chroma board) for good gray at **high** brightness.

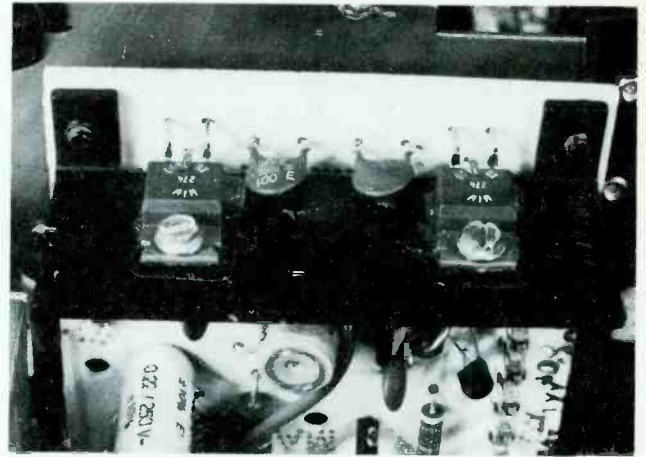

Figure 13. The ZC panel for the regulated +80-volt power supply has interesting circuits for regulation, start-up, synchronization, and over-voltage protection. This picture shows the top of the panel with the two SCR's that are used for regulators. The explanation is too long for the available space now, but the circuit will be clarified thoroughly next month.

Figure 14. This is a simplified schematic of the horizontal sweep circuit, showing the two voltage supplies obtained from the driver, and the regulator. Including the horizontal-output transistor, there are 5 stages: oscillator, buffer, pre-driver, driver, and output.

The oscillator is an electron-coupled type, with frequency and phase (locking) controlled by a DC voltage from the AFC diodes. An extra winding of T1, the driver

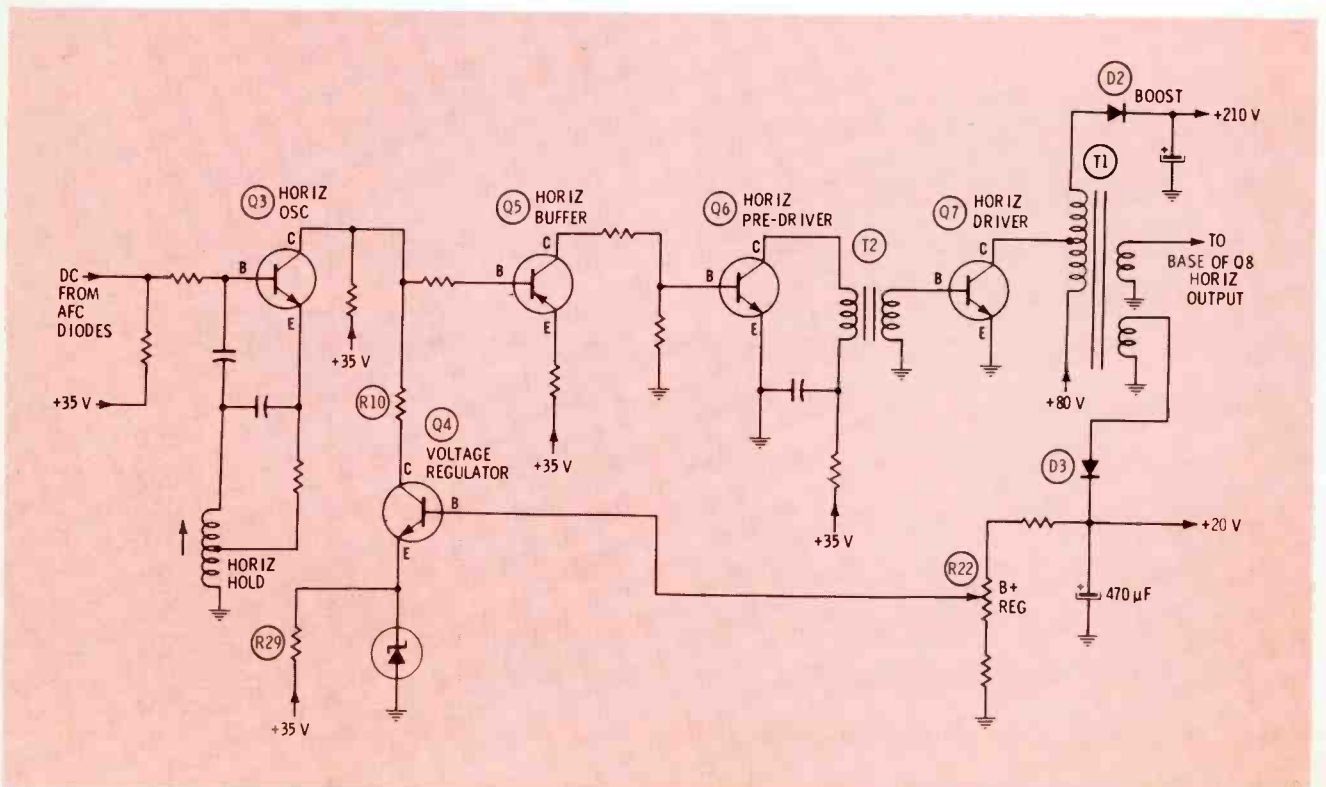

Figure 14

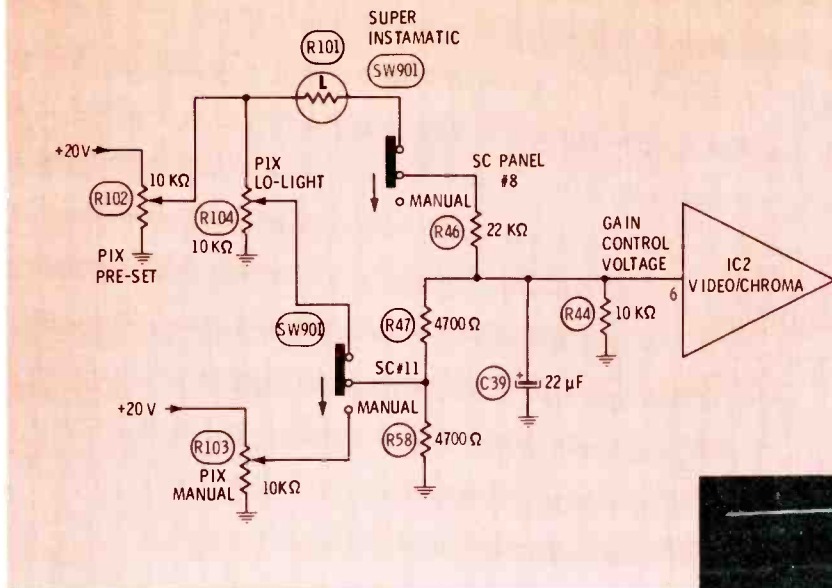

Figure 15

transformer, steps-up the AC voltage from Q7, and it's rectified by D2 to provide the +210 volts needed for the color output transistors. A second winding drives the base of the output transistor, in the usual way.

The voltage from another winding is rectified by D3, and filtered by the 470 microfarad capacitor. This is the +20-volt source that powers many of the low-level stages. Regulation of all the voltages taken from T1, including the 20-volt supply, is accomplished by regulating the +20 volts. A sample of that voltage is taken from the regulator control, R22, and sent to the base of Q4, the regulator transistor. The emitter of Q4 is clamped by the zener, so any variation of the 20-volt supply radically changes the bias of Q4. And the collector current of Q4 determines the output signal from the oscillator Q3.

For example, suppose the DC voltage decreased. Q4 would have less forward bias, causing less collector current, which would increase the AC output from Q3, and the greater signal would pass down the stages giving higher AC signal from T1, thus increasing the +20-volt supply voltage. Of course, an increase of DC voltage would cause a reverse chain of events. If you need to adjust the voltage, the manufacturer recommends that R22 (mounted on the horizontal panel) be adjusted to give an output of precisely +20.6 volts.

Figure 15. Another interesting circuit is the one that increases brightness, contrast, and color intensity when the amount of light falling on the TV increases. It's the "Super" part of the Super-Insta-Matic system of automatic and pre-set functions. A cadmium-sulfide cell (which decreases resistance with stronger light), that's mounted behind a plastic window between the volume control and the Insta-Matic switch, is switched in to replace the pre-set "picture" control. Gains of both video and chroma are controlled by the DC voltage applied to pin 6 of IC2; a higher voltage gives more contrast and color.

Here's how the circuit works: When the light reaching R101 is dim, its resistance is very high, and a small amount of voltage for IC2 comes from R102 (pre-set picture) and R104 (picture low-light control). This low voltage gives moderate contrast and color intensity. A stronger light falling on the sensor reduces the resistance

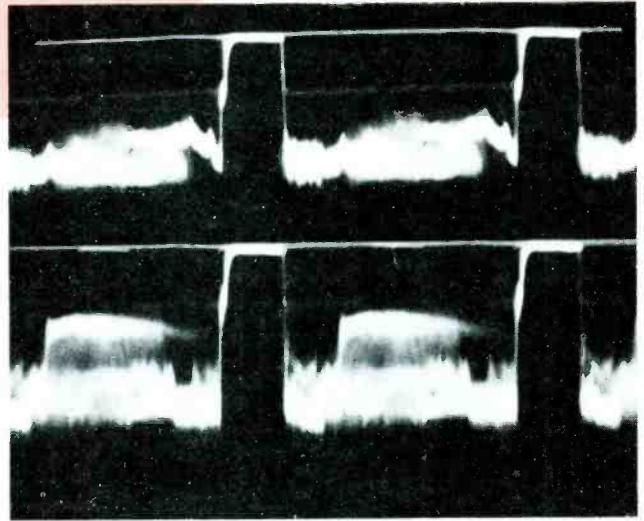

to just a few thousand ohms, thus bringing the full amount of voltage from the pre-set control through R46 to terminal 6 of IC2. The higher voltage at terminal 6 provides increased contrast, brightness, and color saturation.

The waveform at the top shows 130 volts PP and +140 volts DC at the red CRT cathode when the cell was covered, and the bottom trace gives the 210 volts PP and +127 volts at the same cathode when a light illuminated the sensor cell.

Note: the adjustment of R104, the low-light control, has been factory adjusted to match the light-sensitive cell (R101), and should not require any touchup in the field. If the adjustment is turned accidentally, or components are replaced, use this method: switch to Super-Insta-Matic, turn Low-light control fully CCW, and shine a flashlight on the light sensor. Adjust Picture Pre-set and other pre-set controls for slightly more contrast and color intensity that is desirable. Turn off flashlight, cover the sensor, wait a few seconds for picture to darken, then turn up the low-light control until the picture barely starts to brighten. This should be all, but try the flashlight again to prove that the picture brightens as it should.

Next Month—Power supplies are becoming more sophisticated, and the Quasar TS941 has an unusual one with an input choke before the bridge to reduce the voltage, and two SCR's whose conduction time is varied to accomplish voltage regulation. Watch for it. □

Principles of Video Tape Recorders

Part 2/By C. J. Dailing

As promised last December, we are presenting some important features of a typical helical-scan reel-to-reel Video Tape Recorder (VTR), which include a head-to-tape speed of 723 inches-per-second, using a

rotating head controlled by a servo system. Also, the color processor strips the composite video signal into separate elements and reassembles them into a color picture of high stability.

Helical-scan (slant-track) video tape recorders (VTR's) have become quite popular in the fields of business and education. In recent

months, developments of better time-base correctors and editing facilities have allowed the integration of helical machines into TV

broadcast operations (portable versions for electronic journalism, for example) which previously were the exclusive domain of the more-expensive and more-precise quad-head machines.

It seems certain that more helical machines will be used in the future, even though the imminent introduction of video discs probably will block VTR's for home use.

Servicing of VTR's is not recommended as a sideline to be entered into without preparation. But if you like to work on mechanical/electronic equipment, this might be an ideal field for you.

VTR General Specifications

Regardless of the brand or model, any VTR for color-TV programs must be able to handle NTSC video signals with acceptable quality, which includes adequate bandwidth and signal-to-noise ratio, minimum phase shift, plus good mechanical and electronic stability.

Generally speaking, recording with either FM carrier or Pulse-Interval-Modulation (PIM) and a fast tape-to-head writing speed produces adequate bandwidth. Mechanical perfection is more difficult to attain.

IVC Model 800 Specs

The Model 800 by International Video Corporation (IVC) (Figure 1) has been chosen as an example for analysis because many are in use, and I have had considerable experience with that model. Only one model is examined, because the differences between models often are extensive enough to cause confusion.

Model 800 uses 1" tape, in an alpha wrap (slightly more than 360° around the non-rotating hub (Figure 2). Tape speed, relative to the base plate, is 6.91 inches-per-

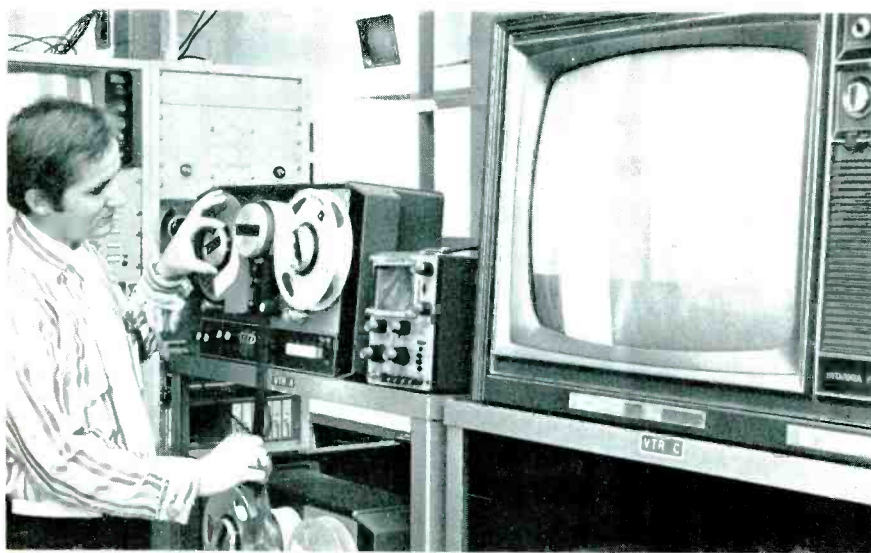

Video tape recorders are of immense value in the educational field. (Courtesy of IVC)

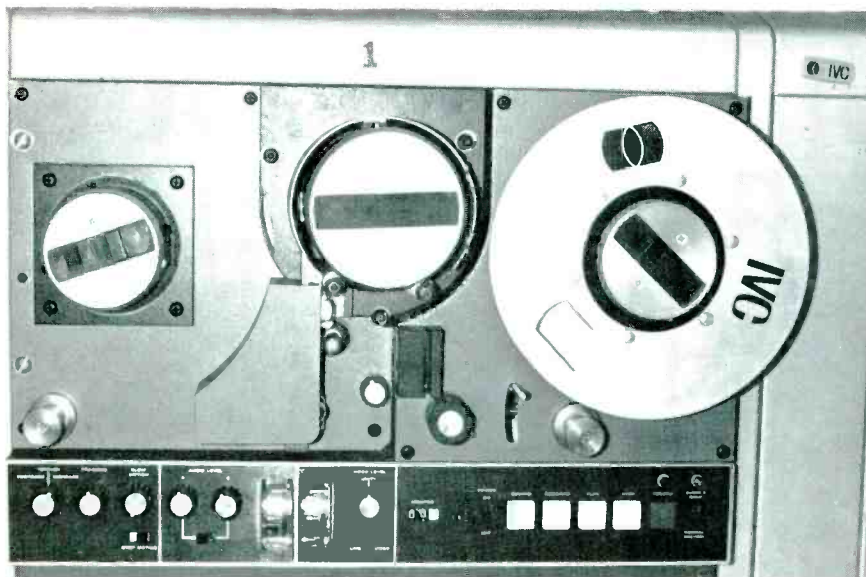

Fig. 1 This is the front view of a rack-mounted International Video Corporation Model 800 video tape recorder, without supply reel or tape.

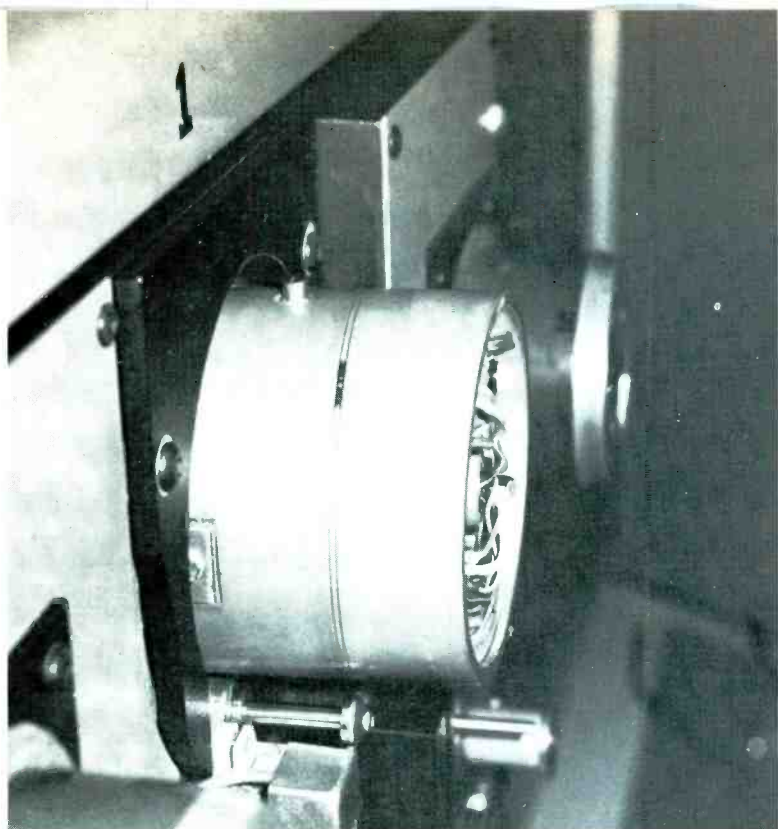
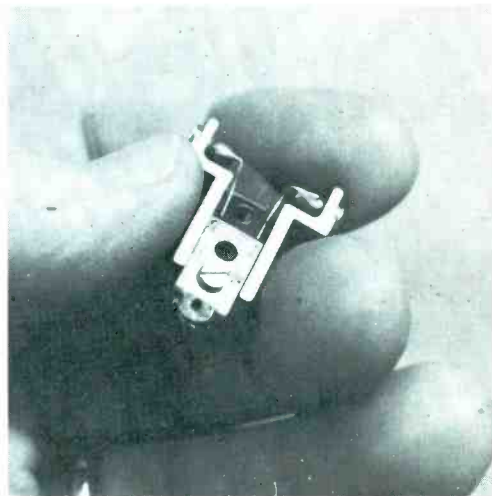

Fig. 2 The 1"-wide tape is wrapped around the non-rotating drum at an angle in a counter-clockwise direction; a worn path can be seen faintly. At the center of the drum is the slot with the rotating-scanner plate, and the video head at about the 11 o'clock position. Notice that the take-up reel (at the right) is spaced away from the panel.



The video head assembly has a tiny tip of magnetic material with a single gap and coil, a coupling transformer, and two lugs for electrical contact. The video signal is transferred (by induction, without contact) between a non-rotating loop on the drum and a rotating loop on the scanner disc.

second (IPS), which added to the 3600 RPM rotation of the video head produces a head-to-tape writing speed of 723 IPS. Tape comes from the left reel, through the various non-video heads and capstan drive, around the hub at an angle, and on to the take-up reel, which is elevated above the base plate.

One video head

Each rotation of the single video head records or plays one vertical field (262½ horizontal lines), including the vertical sync pulse. Most quad recorder problems of hue or color-saturation banding are eliminated by the use of only one active head.

The scanning rotor in the hub has the video head that's adjusted so it dents ("penetrates") the tape during operation. Also, a dummy head with a sapphire tip is mounted on the rotor opposite the video head, to minimize the effects of humidity and temperature on the tape travel. Air pressure from the rotating heads helps to prevent sticking or excessive drag between

the tape and drum.

Figure 3 shows a top view of the hub, with cover removed. The pre-amp components and record/play relay are on a non-rotating board, which has a large window on the left. Through the cut-out window can be seen part of the reflective tape that's used to locate the position of the rotor, and a part of the video-head mounting.

Recorded tracks

Four tracks, each with a different kind of signal, are recorded on the tape (Figure 4). First the tape passes a full-width erase head that removes previously-recorded signals from all the tracks. Next is the Cue (or Audio number 2) head, mounted just before the capstan drive (see Figure 5). Following the capstan is the double head for the Control-track signal, and for Audio number 1. From there, the tape goes directly to the drum and the rotating head, where the tape travels in a spiral so the video tracks appear as parallel diagonal lines.

Did you notice that the video tracks are recorded after the others, and across them? It seems logical for this to cause crosstalk between the tracks; however, crosstalk is no problem. The video tracks run at an angle of almost 5°, and the gaps of the Control-Track and Audio-1 heads (both inside one housing) are tilted 25° in the opposite direction. The total of almost 30° minimizes any crosstalk between them, and this separation is improved by the location of the Control track at the bottom of the tape where there's little video except vertical sync and the signal drop-out caused by the video head jumping from one edge of the tape to the other. Although the Audio 2 (or Cue) gap is not tilted, the track is also along the bottom of the tape where the crosstalk is small enough to meet the less-stringent specs for those functions. Because the video signal is recorded with full tape saturation, and is a coded waveform, there is little chance of the video head picking up crosstalk during playback.

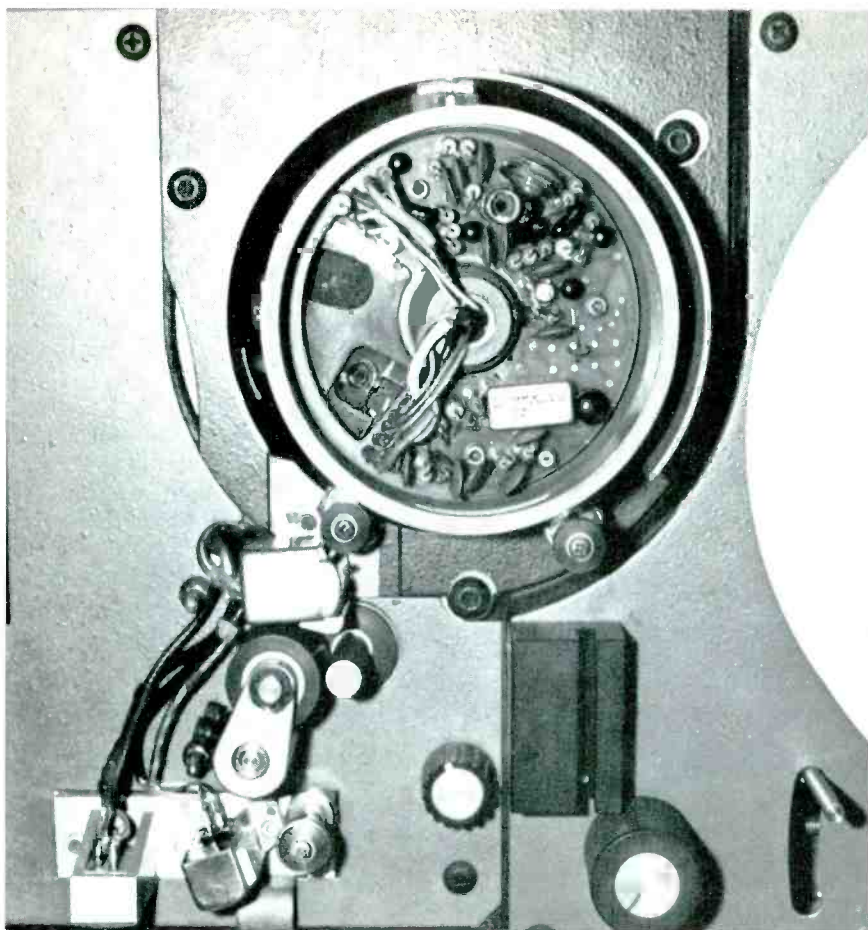

Fig. 3 Removal of the drum cover exposes the pre-amp components mounted on a non-rotating circuit board. Wires come up through the center hole. A window cut out of the board on the left shows at the top the rectangular piece of reflective tape used to determine the position of the head, and a part of the head assembly at the lower left area of the drum. Replacement of the head, or adjustment for tip penetration, can be made through this window in the board.

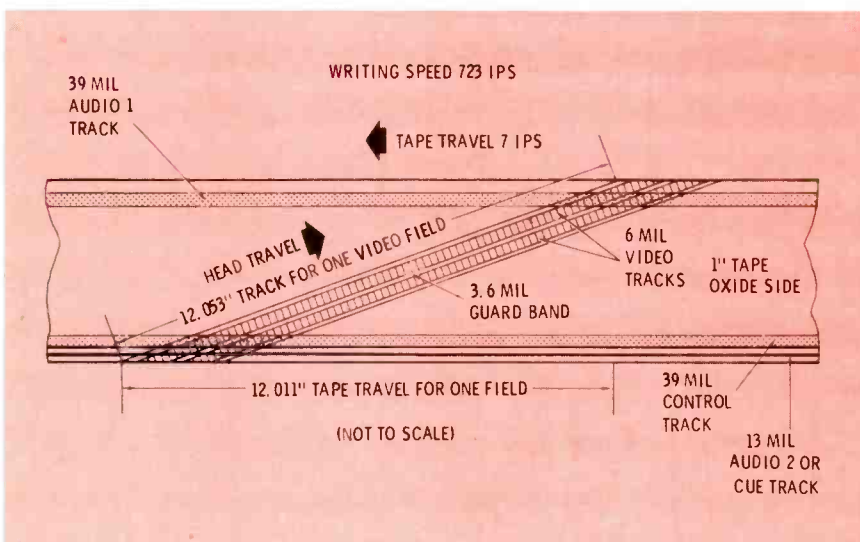

Fig. 4 Three kinds of signals are recorded laterally along the tape, before it reaches the scanning drum where the diagonal video tracks are recorded by the rotating video head. Precautions are taken to minimize crosstalk between tracks. The arrows showing tape and head travel are viewed from inside the drum; the head rotates in a clockwise and the tape in a counter-clockwise direction around the drum.

Record/playback times

Tape reels are 8 inches in diameter, with standard NAB hub, and contain enough tape for a 1-hour program. Rewind time is 90 seconds, or less.

About 3 seconds are required from standby to a stable color picture.

The electronics of recording

A block diagram of the electronic circuits used for recording is shown in Figure 6. There are many differences between audio and video recording methods. For example, audio recorders use a bias-oscillator signal to reduce the distortion of the varying-amplitude signals. Video recorders do not. The video waveforms are recorded at the point of tape saturation; and the signal is severely amplitude-limited, so distortion from clipping is no drawback. Some models swing a carrier in true FM fashion; the IVC 800 records by the Pulse-Interval Modulation (PIM) method in which the amplitude variations of the video are changed into width variations of the constant-amplitude pulses. Then, during playback, the signal is integrated to produce amplitude variations. This produces good signal-to-noise ratio.

The level of video during recording is fairly critical. If it's too low, the signal-to-noise ratio is degraded. If it's too high, compression of the amplitude occurs. To help find the optimum level, a meter is provided. The video gain should be adjusted so the highest meter reading is just under the 100% mark, and preferably should not drop below 70% on scenes of reduced contrast. During playback, this same meter is used to indicate the best reproduction of the video track.

A similar meter indicates the volume of the audio part of the recording. Of course, the audio reading is expected to vary all of the time, but the gain should be adjusted so the loudest peaks do not exceed the 100% mark. The method of recording the audio and control tracks is identical with that used in conventional tape recorders, so it will not be detailed.

Playback electronics

Figure 7 is a block diagram of the playback for black-and-white video. As explained before, the

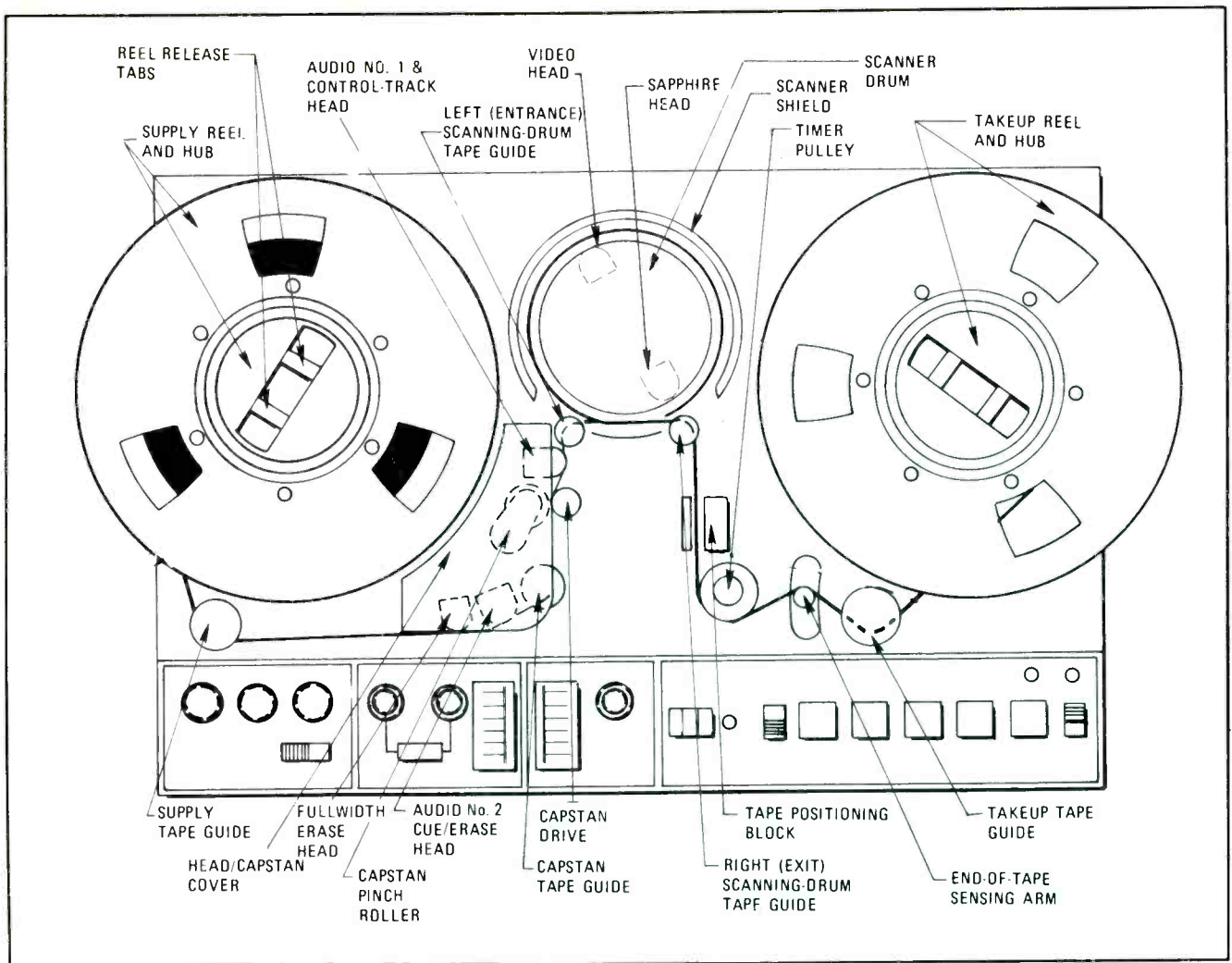

Fig. 5 The tape path, heads, and tape guides are shown here. (Courtesy of IVC)

signal on the tape is not normal video, but it is video that has been coded into pulses whose width varies to simulate the amplitude changes of video. Therefore, limiting can be incorporated before the demodulation (which changes pulses to video again) to minimize the normal tape-amplitude variations, and to improve the signal-to-noise ratio.

Notice the drop-out clamping circuit and the connection to the amplifier of the VIDEO-LEVEL METER. Drop-out clamping minimizes the disturbance when the video head shifts from the end of one track and moves over to the other part of the helical wrap to start a new track. Correct operation of the TRACKING control produces a minimum amplitude of drop-outs (Figure 8). During playback, the meter is switched to read the drop-outs; therefore, the TRACKING control is adjusted for

a minimum reading of the meter.

There are two video output signals. One is direct to an output connector for use with an external

video system or a b-w monitor. The other output signal goes internally to the color-processing board, which is necessary for color programming.

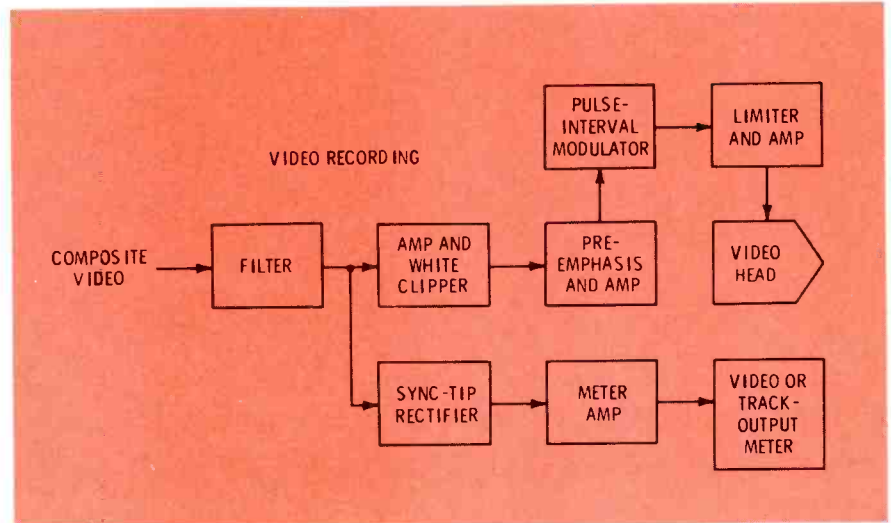

Fig. 6 Circuits for recording are not complicated, except for the Pulse-Interval Modulator where the variable amplitudes of the video signal are changed into constant-amplitude variable-width pulses. Amplitude of the incoming video is monitored by a meter circuit.

Variations of tape motion are too much to permit a satisfactory color picture on a conventional color receiver or monitor. Therefore, the color-processing circuits are required.

Color processing

Control of the video head by servo action can limit frequency deviations to about ± 2 KHz at 3.58 MHz. However, most color receivers can be locked properly only if the deviation is no more than

± 50 Hz. The color processor circuits are required to reduce these tape frequency variations by a factor of 40. This is accomplished by special color demodulation giving R-Y and B-Y signals, which are used to modulate a crystal-controlled oscillator, producing a new chroma signal that is added to the old b-w video to form the new, stable color video signal.

Most of the circuit actions are made clear by the block diagram of Figure 9. But the one factor

making the concept practical is that the 3.58-MHz oscillator can be changed far more in frequency by the phase detector than is possible with conventional receivers. Part of this wide swing is produced by the varactor diode which controls the oscillator.

Output from the color-processing board is a composite color video signal of satisfactory stability and color quality.

Servo control of video head

Figure 10 shows a simplified block diagram of the servo action for both recording and playback. As you can see, quite a bit of electronic circuitry is used for these "mechanical" functions.

The synchronous capstan-drive motor is powered direct from the AC line, and runs at a constant speed for both recording and playback. However, the speed and mechanical phase of the scanner motor for the video head must be adjustable. During recording, it must be properly rotated so the vertical sync pulse occurs just before the drop-out (when the head changes from one track to the next). During playback, the scanner motor must force the head to trace the exact path made during recording, regardless of tape stretching or shrinking.

Speed of the scanner motor is regulated by having the uncon-

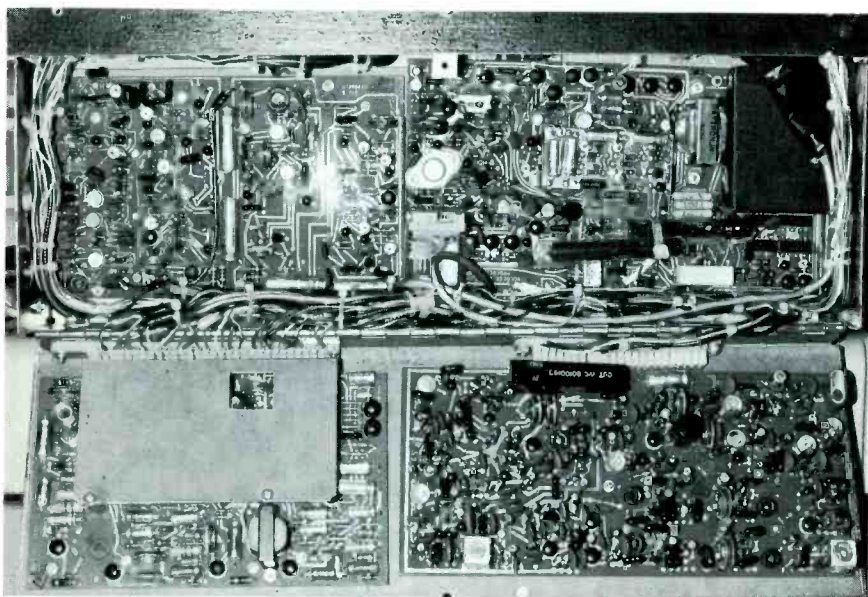

All of the electronic wiring is on these four circuit boards, which are hinged together to save space. Upper left is the modulator board; the servo board is at the upper right; audio circuits are at lower left; and the color-processing board is at the lower right.

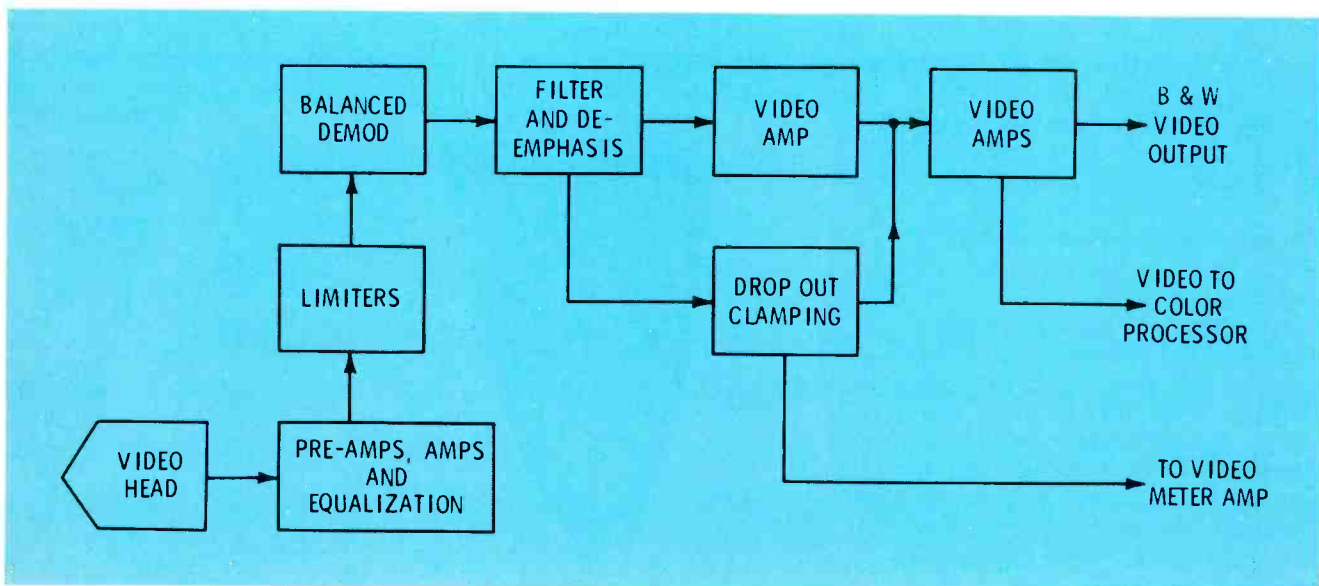

Fig. 7 Playback circuits are shown in this block diagram. The balanced demodulator changes the constant-amplitude variable-width pulses into variable-amplitude video. Drop-out clamping limits the noise that occurs as the video head transfers from the end of one track to the start of another at a different part of the tape. Minimum drop-out level means good adjustment of the TRACKING control, so the TRACKING control is adjusted during playback for minimum meter reading (about 1/3 scale usually).

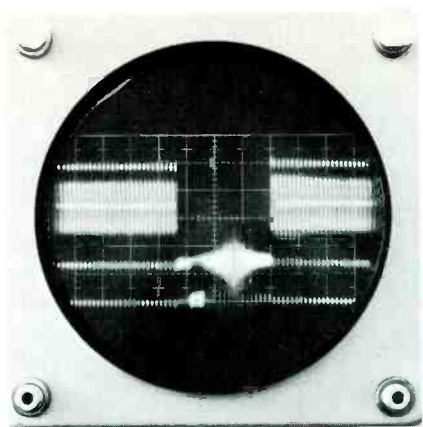

Fig. 8 This scope waveform shows the drop-out noise that should happen at about the 10th horizontal line following the start of vertical sync (scope at vertical rate and expanded). If the drop-out occurs too soon, it would interfere with vertical locking; if it was too late, the disturbance would be seen at the top of the raster.

controlled speed 1% too fast. Then the servo circuit develops a voltage to operate an eddy-current brake (electronic, has no moving parts),

reducing the speed as needed.

The phases of two electronic signals are compared to obtain an error-correcting voltage (similar in effect to a horizontal-phase detector) which controls the eddy-current brake. However, the signals are different during playback than those for recording.

During recording, one signal is the vertical sync pulse that has been removed from the composite video being recorded. The other signal is a pulse obtained from the rotating scanner. A piece of shiny tape is mounted on the rotating section of the scanner so it reflects light from a lamp to a photo transistor when the scanner reaches a certain spot. Therefore, the scanner pulse (called a tach pulse) indicates exactly when the video head is in the desired position. If the scanner drifts ahead of or behind the vertical sync pulse, the "sampler" circuit emits an error-correcting voltage to vary the current through the eddy-current brake, restoring the correct position.

Also during recording, a signal obtained from the vertical sync pulse is recorded on the Control track, for use during playback.

Motor drive during playback

The two signals required to position correctly the video head during playback are the "tach" pulse from the scanner and the pulse from the control track, which was added during recording (see Figure 10). All other functions of the servo circuits are the same as those described for recording.

Motor drive comments

To minimize time-base errors (variations of sync timing because of mechanical problems), the rotation of the scanner and video head is phase-locked to video vertical sync pulses during recording, and to control-track pulses during playback. The position of the video head determines the points where the vertical sync pulses are recorded, and the arrival times of the sync pulses during playback; this is

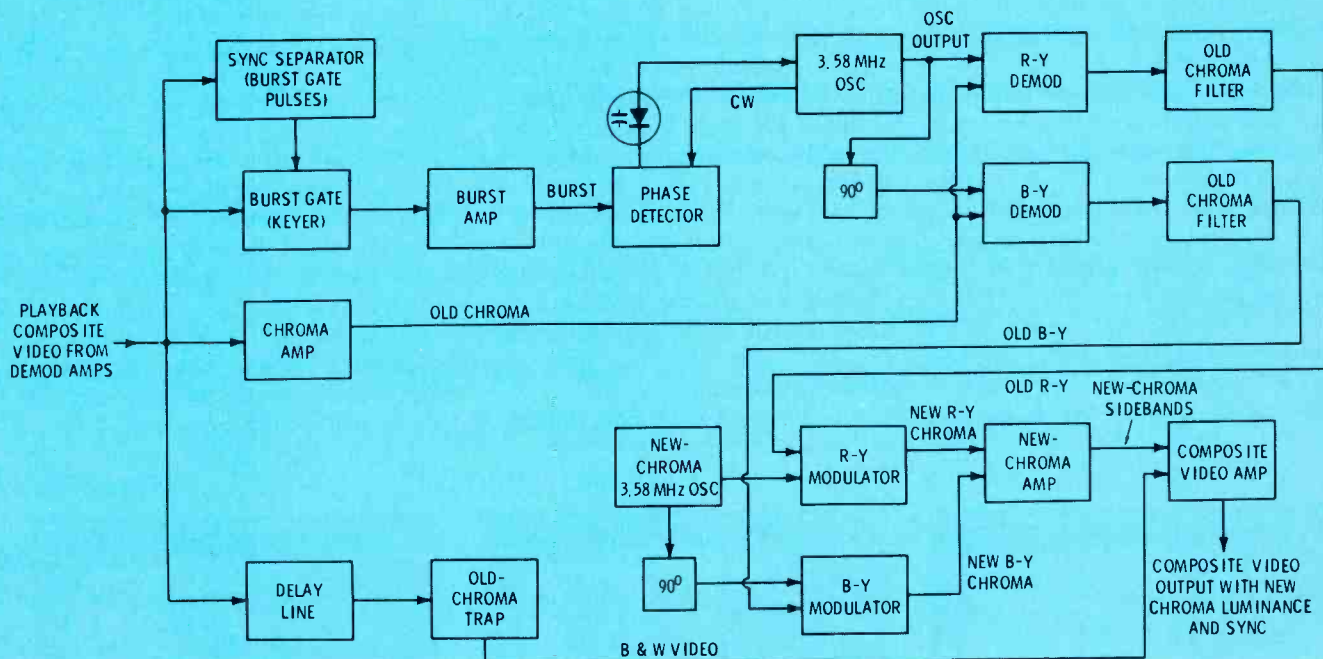

Fig. 9 The circuit of the color processor is more than twice as extensive as the chroma circuit of a color receiver. Horizontal sync is separated, delayed in phase and used to key the burst. The burst and a sample of the 3.58 MHz oscillator operate a phase detector, with a DC output that varies the capacitance of a vari-cap diode. The diode changes the frequency of the oscillator to follow the frequency variations caused by fluctuations of the tape travel. Signals from the oscillator and the "old" chroma are demodulated to produce old R-Y and old B-Y, which modulate a "new-chroma" oscillator to produce new chroma. The new chroma is added to the old b-w video (which has been properly delayed and stripped of all the old chroma) to form new composite video having a minimum of frequency variations, thus giving good color and color locking with any standard receiver or monitor.

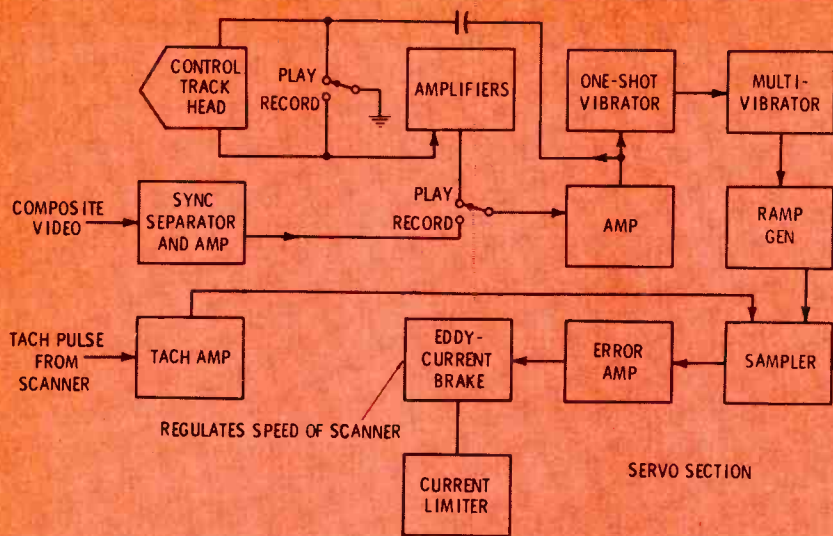

Fig. 10 Position of the rotating video head for both recording and playback is regulated by the servo circuits. During recording, the incoming vertical sync and the tach pulses showing head position (known from the position of the reflective tape that mirrors a light as it passes) are phase-compared so the vertical sync is recorded just before the change to a new track. Also, a filtered sample of vertical sync is recorded on the control track, to be used during playback. For playback control, the control track and tach (scanner location) pulses are compared. Two front-panel controls fine-tune the head position during playback only. An error-correcting voltage is amplified to control the speed of the scanner motor.

tested and corrected once for each vertical field (59.94 times per second for color).

However, variations of temperature and humidity change the tape characteristics, and a tape might have been recorded on another machine with slightly different tension. For these reasons, the servo loop alone is not accurate enough for best playback quality.

Two "fine tuning" controls are placed on the front panel for use **only** during playback. The **TRACKING** control adjusts the servo loop so the video head is phased

correctly on the track, and the **TENSION** control varies the torque of the take-up reel. This changes the amount of tape stretch until it matches the stretch present during recording, keeping the video head in the center of the track, and not to one side. Visually, the effect of tape stretch is most noticeable as a "hook" at the top of the picture. Figure 11 shows some of the symptoms of improper adjustments.

Control of tape motion

The basic tape-motion modes of the Model 800 are:

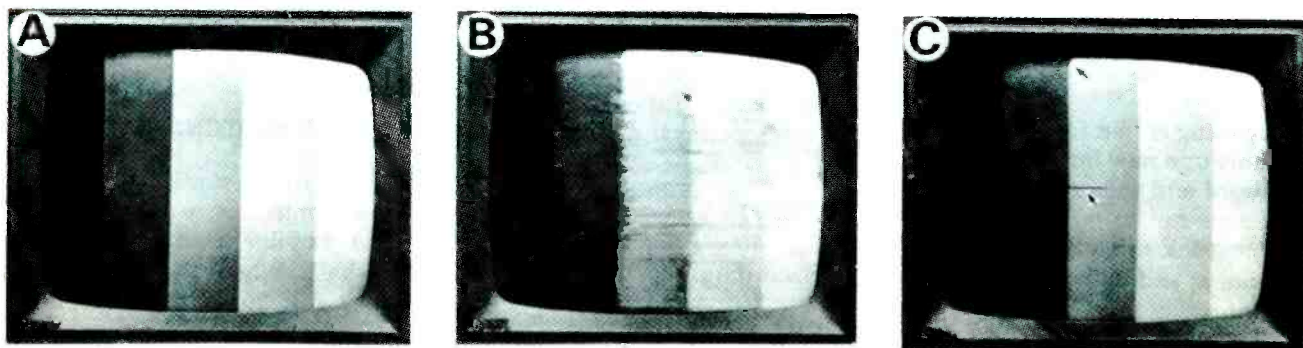

Fig. 11 Picture "A" shows normal color bars. Wrong **TRACKING** adjustment causes horizontal displacement of the scanning lines (picture "B"). The bend at the top of picture "C" is caused by incorrect **TENSION** adjustment. The black line near the center is one kind of a drop-out, usually caused by a bad spot on the tape. (Courtesy of IVC)

- Stop (Standby);
- Play/Record;
- Fast Forward; and
- Rewind.

Because remote operation was a design goal, these modes can be selected by pushbuttons on the recorder, or from a remote point by use of an accessory unit. Including the **RECORD** button (used simultaneously with the **PLAY** to initiate recording), there are five momentary-contact pushbutton switches, two reed switches, one slide switch, and six interlocking relays.

Four separate motors are used. The synchronous ones for capstan and video-head scanning have been explained before.

Stretching or distortion of the tape is such a threat that great care must be taken to obtain a dependable pack of tape on the reels, and to prevent undue stress when starting or stopping the tape travel.

Each reel has an induction motor to supply either a strong torque to move the tape rapidly for rewind of fast forward, or to give a slight pull or braking drag as needed for record and play (Figure 12). Several of the motors can be seen in Figure 13, a bottom view of the base plate.

Brakes

The reel motors are equipped with mechanical brakes, but they are used only for parking, to prevent tape spillage when the machine is turned off. **Dynamic braking stops the tape movement.**

In general, tape motion is stopped by the control logic switching the mechanism for tape travel in the opposite direction. Then the motors are shut off when the tape actually stops, just before reversing.

For example, if the machine was

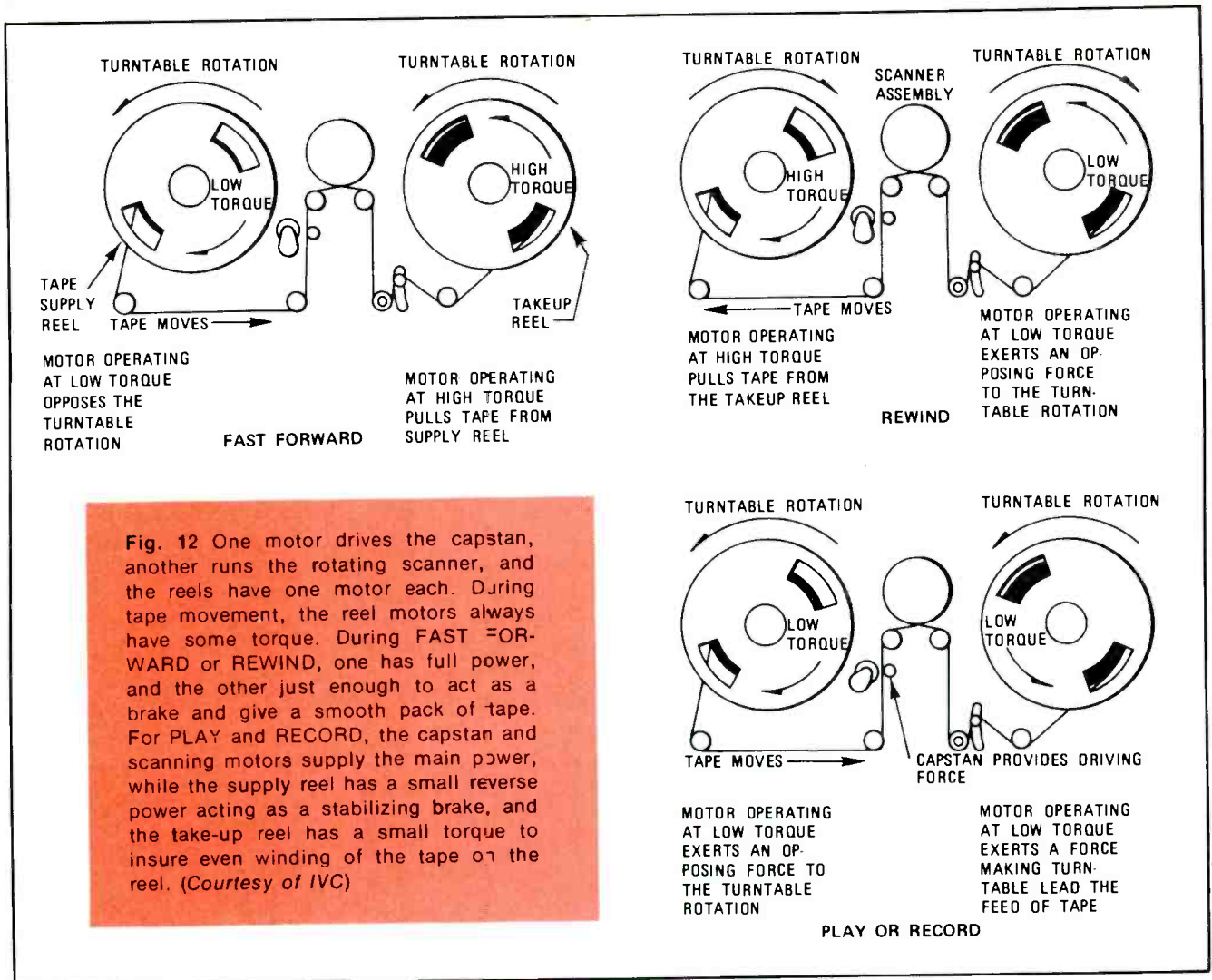

Fig. 12 One motor drives the capstan, another runs the rotating scanner, and the reels have one motor each. During tape movement, the reel motors always have some torque. During FAST FORWARD or REWIND, one has full power, and the other just enough to act as a brake and give a smooth pack of tape. For PLAY and RECORD, the capstan and scanning motors supply the main power, while the supply reel has a small reverse power acting as a stabilizing brake, and the take-up reel has a small torque to insure even winding of the tape on the reel. (Courtesy of IVC)

in REWIND and the tape moving at high speed when the STOP button was depressed, the relays would change to FAST FORWARD. The reversed torque applied to the reel motor would slow the tape movement until it ceased and slowly started in the opposite direction. At that time, the "motion sensor" would de-energize the relays removing power from all the motors (except the scanner motor, which runs all the time the power is on). The brake solenoids would be de-energized also, applying the mechanical brakes. Now, the end-of-tape arm is pulled away from the tape, permitting it to lie slack so there is no contact with the rotating scanner. The machine is in standby.

Summary

A complete description of the IVC Model 800 would more than fill this entire magazine. In fact, the factory manual is about 5/8-

inch thick! Yes, video-tape recorders are very complicated, both electronically and mechanically.

Servicing of VTR's can be interesting and profitable. However,

we advise some advance study and preparation, such as taking a short course from the specific manufacturer whose machines you intend to service. □

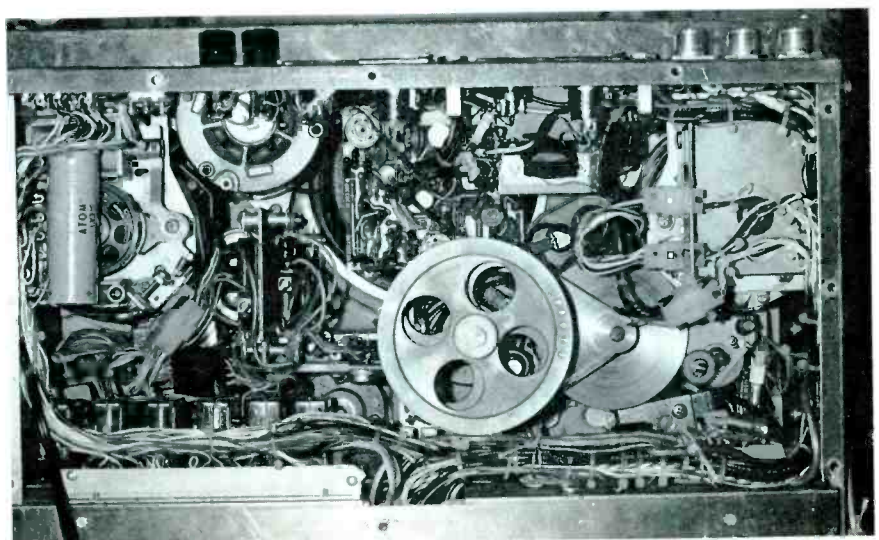

Fig. 13 This view of the base plate shows three of the motors and the mounting plate of the fourth, and gives an idea of the mechanical complexity.

Reports from the test lab

By Carl Babcoke

These monthly reports about electronic test equipment are based on actual examination and operation in the ELECTRONIC SERVICING laboratory. Observations about the performance, and details of new and useful features are spotlighted, along with tips about how to use the instruments for best results.

Three products of one manufacturer will be reviewed this month. They are the Lectrotech TO-60 dual-trace scope (\$489.50), BG-10 small color generator (\$89.50), and the SCA-300 Sweep-Circuit Analyzer for injecting horizontal and vertical drive signals (\$49.50).

Lectrotech TO-60 Scope

The Lectrotech Model TO-60 dual-trace, solid-state, triggered-sweep scope offers just about all the features possible. Some of the highlights are:

- a 5" CRT with green phosphor plus a blue filter gives good brightness and a blue trace. The edge-

lighted graticule has 8X10 CM markings, and an extra vector graticule is included;

- all solid state (except for CRT);
- operates in single beam, dual-trace, or vector modes;
- triggered horizontal sweep has 18 ranges from .2 second to .5 microsecond per division, plus a variable control. Also, an X5 switch widens the visible portion of a waveform by a factor of 5. Built-in sync separator gives easy locking of video at either frame or line frequencies. Only one combination TRIGGER LEVEL and AUTO locking knob is required, in addition to switches that select sync source and polarity.

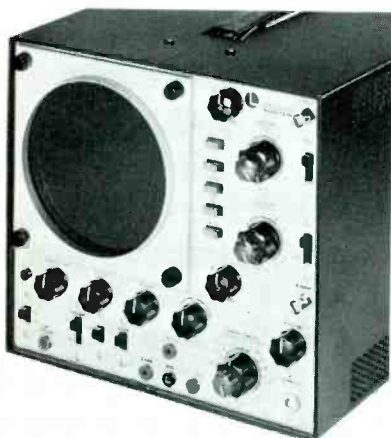

The Lectrotech Model TO-60 dual-trace, solid-state, triggered-sweep scope has all the features commonly associated with lab scopes.

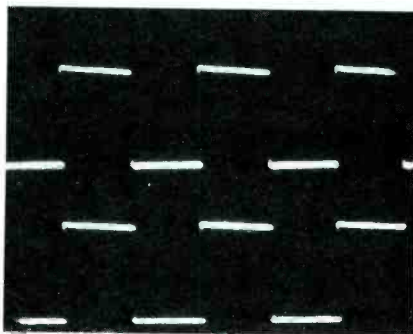

Low-frequency response of the vertical channels was excellent, as proved by the lack of tilt of the 20-Hz square waves on AC (top), compared to the same signal with the DC coupling (bottom trace).

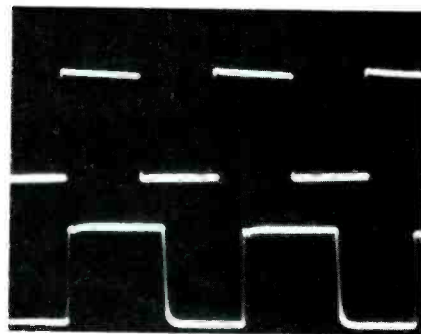

Square waves of 20 Hz (top trace) and 200 KHz (bottom) also show good high-frequency response and absence of ringing. The same audio generator was used for all our scope evaluations to date, so you can compare waveforms.

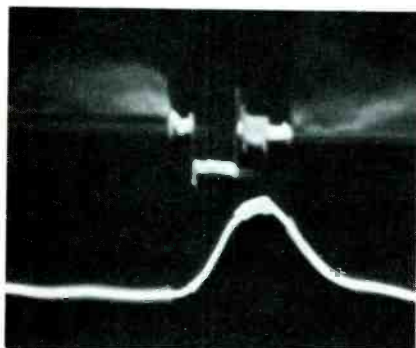

Dual-trace operation allows phase comparison of two signals. In this case, the top trace shows negative-going composite video, and signals at the grid of a burst keyer are shown by the bottom trace. Both were widened by the X5 feature.

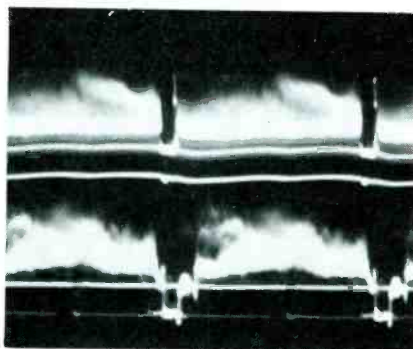

A built-in sync separator allows rock-solid locking of video waveforms, both at vertical or field rate (top) and horizontal or line rate (bottom).

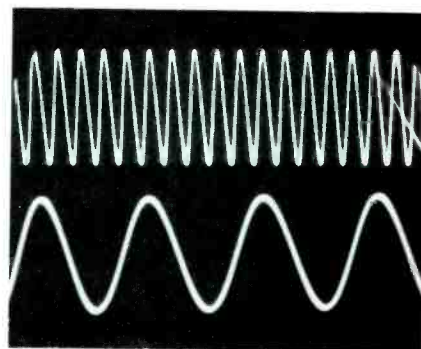

About 21 cycles of a 3.58-MHz carrier can be displayed at the shortest horizontal sweep time of .5 microsecond (top trace), while only 4 1/2 are seen when the X5 width multiplier is added.

AUTO gives a horizontal line, even without a vertical-input signal;

- two identical vertical amplifiers are provided for dual-trace operation. Response is more than 15 MHz, with 11 ranges from .01 volts/div to 20 volts/div in 1-2-5 sequence. With an X10 probe, up to 800 volts PP can be measured. Each range switch has a variable gain control, and calibration is correct when fully clockwise. Each channel has a centering control;
- switching of channels for dual-trace operation can be either alternate or chopped, selected by push-buttons; and
- PR-10 Direct/Low-cap probes and PR-12 Demodulator probes are available.

Operation of the Lectrotech TO-60 dual-trace scope during waveform measurements on a color-TV chassis was very good, and without noticeable drift of any kind. Solid locking, and bright waveforms of moderate trace sharpness were other advantages.

Lectrotech BG-10 Color Generator

The BG-10 is a pocket-sized battery-operated color-bar and dot-crosshatch generator. Space is provided for the shielded output-signal cable inside the metal case. Power is turned on automatically when the case is slid partially open (red light

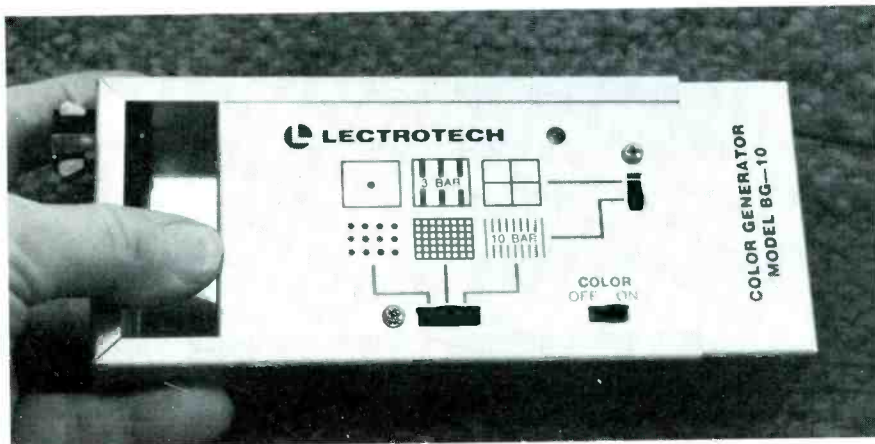

The Lectrotech model BG-10 color generator is pocket-sized, battery-powered, and has CMOS LSI IC's in the count-down circuits so that no recalibration is ever necessary.

indicates power), and closing the case turns off the power of the two ordinary 9-volt radio batteries.

Six different patterns for color adjustment or troubleshooting are selected by two switches, and another turns on the color carrier. Notice that the crosshatch has squares, not rectangles.

All frequencies (except the RF carrier for the channel) come from two crystal-controlled oscillators, and there are no adjustments of the count-down circuits, which are CMOS Large Scale-Integration (LSI) in IC's. It's impossible for the bars or lines to jump out of sync. If you operate the unit until the batteries are **completely** discharged, there might be tearing or jagged displacement of the vertical lines. That's your clue to replace the batteries.

All the patterns were perfectly stable and very sharp.

Lectrotech SCA-300 Sweep-Circuit Generator

Solid-state output transistors require drives of lower amplitudes and impedances than those used with tubes. The SCA-300 has a 15.750 Hz oscillator and a transistor power amplifier to supply up to 12 volts PP of square waves for horizontal drive requirements. For vertical, a signal of 28-volts PP 60-Hz sine waves is taken from a power transformer.

FAST RELIEF FROM SOLID STATE HEADACHES



STOCK
THIS
FAST
SELLER

Now with
E-Z Hook leads!

There's nothing else like the Hickok Model 215 Pocket Semiconductor Tester.

- It's simple to use — no set up — no data books.
- It automatically determines lead configuration.
- LED displays indicate if semiconductor is GOOD or BAD and identifies base lead (gate for FET's) and whether NPN or PNP.
- Operates on 9V batteries.
- Weighs only 12-ounces and fits in your pocket.

We back the Model 215 with the best warranty in the business — two full years.

The Model 215 or our bench Model 220 are values you have to see to believe. Ask your Hickok distributor for a demonstration or contact us for more information.

SUMMER SPECIAL ~~\$138.00~~ \$124.00

HICKOK

the value innovator

INSTRUMENTATION & CONTROLS DIVISION
THE HICKOK ELECTRICAL INSTRUMENT CO.
10514 Dupont Avenue • Cleveland, Ohio 44108
(216) 541-8060 • TWX: 810-421-8286

For More Details Circle (11) on Reply Card

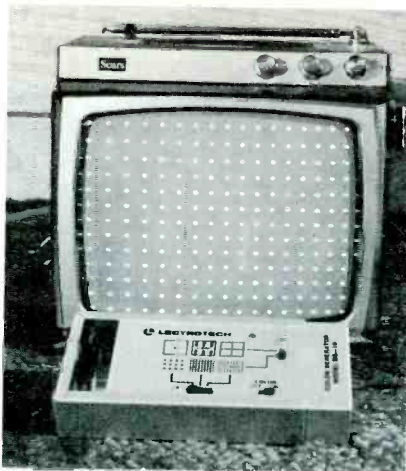
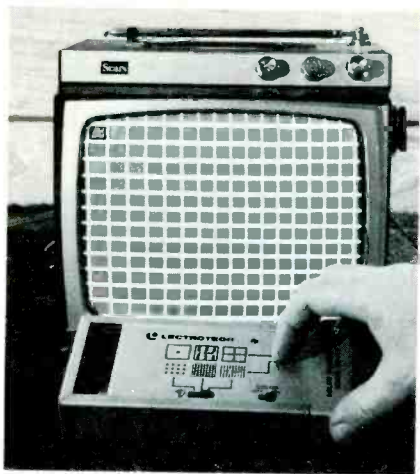

Six different patterns are available from Model BG-10. Notice the many lines of the full crosshatch, and that the areas are square, not rectangular. There are sharp black bars between the color bars. Other patterns that are not pictured are three color bars, one vertical line and one horizontal line intersecting at the center, and one dot exactly at the center.

Lectrotech Model SCA-300 supplies 15,750-Hz square waves or 60-Hz sine waves for signal-substitution tests in horizontal and vertical solid-state sweep circuits.



Waveform at the top is the 28-volt PP 60-Hz signal, and at the bottom is shown the 12-volt PP horizontal-frequency square waves for driving solid-state circuits.

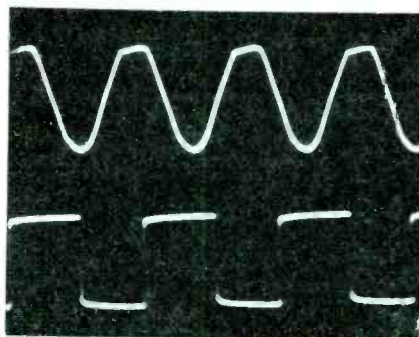

Although the SCA-300 is specified for solid-state tests only, the vertical-drive signal is sufficient to drive the grid of either the output or oscillator in tube sets. Pictured is the full screen that resulted when the vertical signal was applied through a .05 capacitor to the grid of an oscillator. The picture rolled slowly downward, and had retrace lines, but it also had more than full height.



Either horizontal or vertical signal is selected by the HORIZ/VERT switch, a 1,000 ohm pot controls the amplitude, and the signal is coupled to the test leads through a 25-microfarad non-polarized electrolytic capacitor.

Instructions in the operating booklet tell where and how to connect the test waveform, which is used to substitute for a missing vertical- or horizontal-sweep drive signal. For example, too little drive to a transistor horizontal-output transistor might ruin the transistor, and too much might cause areas of insufficient width.

Although this signal-substitutor is intended for use with solid state, the vertical signal is strong enough to work fine with tube-type vertical circuits.

Of course, it must be understood that a substitute signal of this kind is intended **only** to prove the absence of a drive voltage. Linearity and width or height usually is not normal, nor is there any locking at all. When employed as intended, the tests are very helpful and valid.

Summary

All three of these test instruments operated just as they are supposed to do, without any problems. □

productreport

These features supplied by the manufacturers are listed at no-charge to them as a service to our readers. If you want factory bulletins, circle the corresponding number on the Reply Card and mail it to us.

Analog Panel Meters

Available in both taut band and pivot-and-jewel versions, the Mustang line of analog panel meters from **Weston Instruments** can be adapted as DC ammeters and voltmeters, or AC rectifier-type voltmeters.

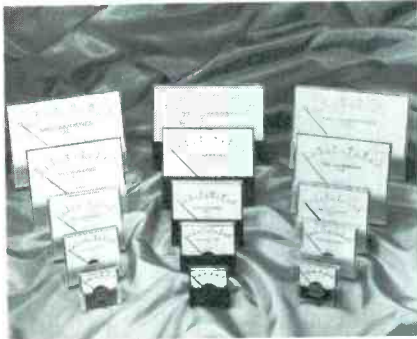

The meters are available for front and bezelless back-of-panel mounting in 1½- to 4½-inch sizes, plus a 6-inch front-mounting unit. Ring-lock installation reportedly eliminates the need for mounting hardware, and reduces installation time and cost.

For More Details Circle (50) on Reply Card

Amateur Radio Study Course

From 5 Watts to 1,000 Watts is a programmed study course from **Radio Shack** which is designed to help the student earn an amateur radio license, as well as learn basic electronics.

The course takes a step-by-step approach through the basics of learning Morse code, to the electronic theory, and regulations for the novice, technician, and general-class Ham licenses.

Each step is followed by a checkpoint which asks for a use or practical application of the information. Reportedly, the basic philosophy of the book is understanding concepts, rather than memorizing a list of facts.

The course is priced at \$2.25.

For More Details Circle (51) on Reply Card

Double-Barrel Epoxy

Model 33-104 from **Workman Electronic**, contains epoxy glue in a double-nozzled, self-measuring dispenser. It's easy to use, just push the piston to measure equal parts of hardener and resin.

For More Details Circle (52) on Reply Card

THERE ARE TWO GOOD WAYS TO CARE FOR TUNERS...

And they're as different as Night and Day.



Tiny Miniscrubbers™ imbedded in a thick coating of polish.

Washes clean and leaves a soft, slick non-sticky film.

As popular as **BLUE STUFF** is . . . a lot of technicians just prefer an old fashioned solvent-lubricant. So we decided to invent a brand new old fashioned solvent-lubricant for them. **Rz** is unquestionably the finest tuner solvent-lubricant to come along. It washes clean and leaves a slick but not sticky film. And we still have **BLUE STUFF**.

So now you get to do it your way . . . and either way the best is from

**TECH
SPRAY**

where we find solutions for your problems

Snap-in Soldering Tip

A new snap-in tip is featured in all models of Iso-Tip Cordless Soldering Irons manufactured by the **Wahl Clipper Corporation**. Instead of

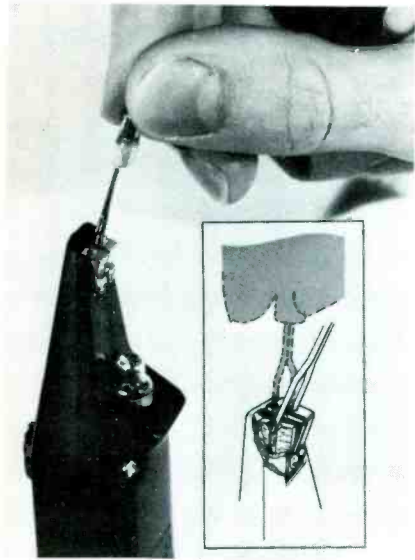

having to loosen and retighten mounting screws to replace a tip, simply insert the tip and snap into place. No further locking is required, although the tip can be tightened if desired.

For More Details Circle (53) on Reply Card

Moisture-Damage Preventative

WD-40 is useful for many jobs around an electronic shop. This spray-can product of the **WD-40 Company** frees sticking mechanisms, loosens rusted parts, and drives out moisture from motors, circuit boards, potentiometers, and TV tuners. It is a non-conductor of electricity, and is said to be safe for use with most materials.

For More Details Circle (54) on Reply Card

Television-Interference Filters

Two RF filters developed by **Avanti Research And Development** are designed to minimize TV-program interference caused by CB transmitters.



If the interference is caused by harmonics of the transmitting frequency falling on a television channel (such as Channel 2 or 5), installation

of a Low-Pass TV-Interference Filter in the antenna coax cable of the transceiver should remove the problem.

Then, if interference still persists, perhaps the tuner in the TV is overloading. Avanti's 27-MHz CB Signal-Rejection Filter installed between the download and the TV antenna terminals should trap the unwanted CB signal, and allow the TV frequencies to pass unhindered.

For More Details Circle (55) on Reply Card

Compact Tool Kit

A 24-piece tool kit, JTK-6, includes 7 sizes of screwdrivers, an adjustable wrench, 2 pliers, wire stripper, knife, 2 alignment tools, stainless rule, hex-key set, scissors, 2 flexible files, burnisher, miniature soldering iron, solder aid, coil of solder, and desoldering braid.

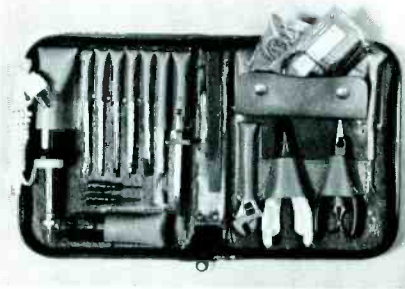

The \$49.00 kit from **Jensen Tools and Alloys** comes in a padded zipper case and fits easily into a desk drawer or glove compartment.

For More Details Circle (56) on Reply Card

Pre-Spaced Letters for Signs

For professional-looking signs, **Seton Name Plate Corporation** has made available pre-spaced and pre-aligned letters and numbers. The

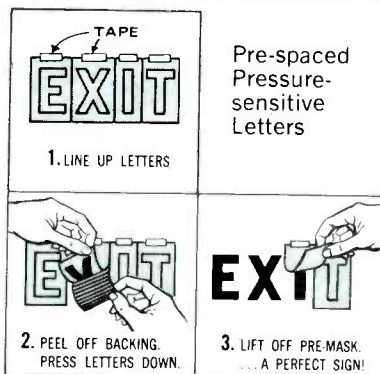

built-in position of each letter on its own masking sheet makes perfect line-up of the letters quick and easy. Simply place the selected letters against each other with the top and bottom of the masking sheet in a straight line.

Six colors of vinyl, two fluorescent colors, and seven colors of Scotchlite Reflective are available in 1-inch to 12-inch sizes.

For More Details Circle (57) on Reply Card

Luminated Micromagnifier

Circon's Luminated Micromagnifier provides the magnification and illumination for micro-procedures not re-



quiring a binocular microscope. Consisting of a large lens surrounded by a Circline fluorescent tube and mounted on a spring-balanced extension arm, the magnifier can be raised, lowered or tilted at any angle.

The bi-convex ground lens reportedly provides low-distortion, 3-power magnification, and good depth perception. Because the unit has an 11-inch working distance, tools may be used on the subject being viewed. Auxiliary lenses can be clipped onto the unit for greater magnification.

A fluorescent tube furnishes shadow-free 360° illumination of the subject, and supplies 500 foot-candle illumination which may be used for hours without becoming uncomfortably warm to the operator. The standard lamp has a 7500-hour life.

The unit remains in any position without clamping or adjustment. Ceiling, desk, wall and floor mounts are available.

For More Details Circle (58) on Reply Card

Semiconductor Guide

The 1975 edition of the **GTE Sylvania** ECG semiconductor catalog and replacement guide cross references 106,000 industry part numbers.

Listing 32,000 more part numbers than the previous edition, the \$2.95 guide covers consumer, industrial, and commercial solid-state devices for domestic and imported products.

Designed as a quick reference for technicians, the 215-page illustrated guide includes discrete devices, digital integrated circuits, hybrid modules, and linear integrated circuits in the ECG line.

For More Details Circle (59) on Reply Card

Had a funny
experience lately?
Send details
to Reader's Chuckles

bookreview

Color-TV Field-Service Guide, Volume 5

Author: Howard W. Sams Editorial Staff

Publisher: Howard W. Sams & Co., Inc., 4300 West 62nd Street, Indianapolis, Indiana 46268

Size: 184 pages, book number 21108

Price: \$5.50 paperback

Volume 5 enables technicians to service color TV's more efficiently in the home. Chassis layouts show the type, function, and location of tubes and transistors used in a particular set, as well as the ratings and locations of fuses and circuit breakers. Horizontal-AFC diodes (where used) are identified as to type and location. One valuable feature of the book is the location of service controls and adjustments shown on the chassis layout. At last, the technician can make field adjustments confidently without worrying about adjusting a bandpass or IF transformer by mistake. Specific field-adjustment procedures for a particular chassis are given on the page facing the chassis layout. These procedures include horizontal sweep, AGC, color AFC, purity, and gray-scale adjustments. Volume 5 is simple to use, and includes an index for all five volumes.

Radio: Theory & Servicing

Author: Clyde N. Herrick

Publisher: Reston Publishing Company, Inc., P.O. Box 547, Reston, Virginia 22090

Size: 310 pages

Price: \$12.95 hardbound

Combining radio theory with practical servicing information, this text features state-of-the-art coverage, with emphasis on solid-state designs incorporating bipolar and unipolar transistors, integrated circuits, and related semiconductor devices. Basic principles of outer-space radio communication are provided, with an introduction to the cooled paramagnetic maser amplifier. Wide coverage of receivers and transmitters includes broadcast AM and FM receivers; automobile, CB, marine, aircraft, and amateur radio; walkie-talkies; FM-stereo (multiplex) transmission and reception; quadriphonic sound; multiband receivers; single-sideband communication; telephone radio, microwave radio relay, and telemetry systems; satellite principles; converters; radio teletype; principles of facsimile; and surveillance "bugs". □



New 2½ digit Heathkit DMM - only \$79⁹⁵

The new Heathkit IM-1212 Digital Multimeter is the DMM you've been looking for... it's easy to read, has built-in calibration standards, service bench styling, easy assembly...and it's low cost. Four overlapping AC and DC voltage and current ranges and five resistance ranges make operation fast and easy. Accuracy is very good for a meter in this price range: 1% on DC volts, 1½% on AC volts and AC/DC current, and 2% on resistance. Full scale ranges are: DCV, 2, 20, 200, 1000V; ACV, 2, 20, 200, 700V rms (25 Hz to 10 kHz); DC current, 2, 20, 200, 2000 mA; AC current, 2, 20, 200, 2000 mA (25 Hz to 10 kHz); Resistance, 200, 2k, 20k, 200k, 2000k ohms. Lighted panel indicators show overrange, positive and negative DC voltages and current. All solid-state design uses IC circuitry for clear, non-blinking display with readout update every 16 msec. and automatic decimal positioning. Overload protected. 120/240 VAC. Also available assembled for only \$125*.

See the complete line of Heathkit instruments in your FREE Heathkit catalog.



HEATH Schlumberger	Heath Company, Dept. 25-07 Benton Harbor, MI 49022
Please send my free 1975 Heathkit Catalog.	
NAME _____	
ADDRESS _____	
CITY _____	STATE _____ ZIP _____
*MAIL ORDER PRICES; F.O.B. FACTORY. PRICES & SPECIFICATIONS SUBJECT TO CHANGE WITHOUT NOTICE.	
TE-326	

antenna systems report

These features supplied by the manufacturers are listed at no-charge to them as a service to our readers. If you want factory bulletins, circle the corresponding number on the Reply Card and mail it to us.

Mobile "Fazer" Antennas

Avanti Research & Development

has introduced a mobile antenna system that features two 48-inch center-loaded "Fazer" antennas in a co-phased arrangement to help minimize the problem of a skewed or shifted radiation pattern.

Center-loading raises the coil well above the vehicle's roof, so that radiation is over the roof and more in the clear than with a base-loaded antenna.

Easily mounted to outside rear-view mirrors, the antennas are removable for transfer from one vehicle to another.

For More Details Circle (60) on Reply Card

Subscriber-Tapoff System

An MATV and CATV subscriber-tapoff system which can turn on and off any number of individual outlets from a central location has been announced by **Blonder-Tongue Laboratories**.

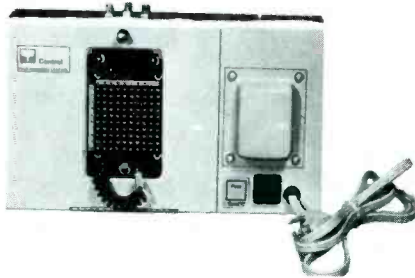

Called Centap, the system can be wired in the normal vertical riser manner used in multiple-dwelling buildings. According to the manufacturer, the system can be installed for 1/7 the cost of a "home-run" system, where each signal coax must connect to a master panel.

Model 4960 Control is tamperproof. The central unit reportedly is able to detect unauthorized misuse of the subscriber outlet. Built-in test facilities permit monitoring the condition of each subscriber's tap.

For More Details Circle (61) on Reply Card

Coaxial Conversion Kits

Two UHF-VHF 300/75-ohm coaxial conversion kits from **The Finney Company** provide everything needed for installation. Each kit contains a 300/75-ohm weatherproof antenna transformer, weather boot, 75-ohm foam-filled coaxial cable, factory pre-assembled fittings, and a 75/300-ohm UHF-VHF set splitter.

The units are available in 75- and 100-foot lengths, and are priced from \$16.60 to \$19.35.

For More Details Circle (62) on Reply Card

CB Mobile Antennas

Four new Citizens-Band antennas designed for mobile applications feature a base-loading coil for improved efficiency, low angle of radiation, and a VSWR of 1.5:1 or less.

According to the manufacturer, **Antenna, Incorporated**, each model includes a heavy-duty stainless steel impact-protector spring with triple-chrome-plated brass fittings to protect the antenna from damage when struck in low clearance areas.

Two models use 34-inch untapered whips designed to help resist whip-bending at high speed. The other models use a 33-inch fiberglass whip for extra stiffness. All units are complete with 17-inches of coaxial cable and connector.

Two different mounting options are

available: a snap-in type; and a no-holes trunk lip mount. The price of the antennas range from \$21.25 to \$28.88.

For More Details Circle (63) on Reply Card

Eight-Way MATV Splitter

Winegard Company has developed a 75-ohm amplified MATV splitter designed to divide RF signals on a single trunkline into 8 outputs with no signal loss.

AS-8 splitter is ideal for use in high-rise buildings and other applications where multiple trunk lines are needed in a single location. Maximum input level per channel is 44 dBmV for each of 7 VHF channels and 5 UHF channels at 0.5% cross modulation.



Bandpass on VHF is 30 MHz to 275 MHz, and 470 MHz to 806 MHz on UHF covering both the mid- and super bands for systems using signals from 30-channel CATV.

For More Details Circle (64) on Reply Card

Solid-State Modulators

Four modulators for adding closed-circuit TV programs to MATV or CATV systems have been announced by **Blonder-Tongue Laboratories**. The modulators accept audio and composite-video signals and generate a TV channel signal.

Model AVMT-4923 furnishes picture and sound carriers for any single VHF TV channel, for use with a single TV receiver or added to an unused channel of a MATV system.

Only a picture carrier (no sound) on any single VHF channel is provided by Model VMT-4922.

Model VM-4925 is similar to VMT-22 except the bandwidth of the video can be up to 8 MHz for sharper pictures, or for accepting the combined picture and sound signal from a microwave down-converter.

Sound only (no picture) is provided on any single VHF TV channel by Model AMT-4921.

For More Details Circle (65) on Reply Card

THE NLS LM-3 VOLKSMETER

World's lowest priced precision digital multimeter -- more accurate and rugged than the old pointer meter -- ideal for field service.



With rechargeable batteries and charger unit

\$125

Standard Features:

- Automatic polarity and zeroing. • Large 0.33" LED display. • 13 ranges: vac, vdc & ohms with 1% accuracy. • Size: 1.9"H x 2.7"W x 3.9"D.

LM-3 basic meter also available in four digits with 0.02% accuracy. Ask for LM-4.

See your local distributor!

Distributor inquiries invited.



Non-Linear Systems, Inc.

Originator of the digital voltmeter.

Box N, Del Mar, California 92014

Telephone (714) 755-1134 TWX 910-322-1132

For More Details Circle (14) on Reply Card

What would you like
to read in ES?
Send in your ideas.

audio systems report

These features supplied by the manufacturers are listed at no-charge to them as a service to our readers. If you want factory bulletins, circle the corresponding number on the Reply Card and mail it to us.

AM/FM Stereo Tuner

Sansui has just released Model TU-4400 AM/FM stereo tuner, which features several new IC's—one in the IF, and several IC's for the multiplex and AM tuner circuits.

The front end has a low-noise dual-gated MOS FET and a 3-gang linear-tuning capacitor. Sensitivity is reported at 2.0 microvolts, selectivity better than 60 dB, and spurious response better than 70 dB.

In the FM section, the IF is a 3-stage type using two linear-phase bi-resonator ceramic filters and an IC limiter. The limiter, together with 3 transistors, works as a muting circuit.



The power supply of the \$199.00 unit has a constant voltage output for reception stability.

For More Details Circle (66) on Reply Card

FM Wireless Intercom System

Model FMW-2 is a 2-channel, 2-station FM wireless intercom system which uses phase-locked loop FM circuitry to help blank out background hum, static, and interference caused by fluorescent fixtures, dimmer switches, and electrical motors operating on the same power line.



No installation is required; each master intercom unit plugs into an AC outlet. For privacy and conven-

ience, two channels are provided, which permits two simultaneous talk paths or selective calling of a particular station. Systems can be operated between buildings if they share the same power line.

Product features include a large press-to-talk panel with a lock switch for continuous talking or monitoring, a combination speaker-microphone, red "ready" light, and on-off/volume control.

Solid-state FM circuitry gives instant operation. Additional stations can be added to the system, manufactured by **Fanon/Courier Corporation**.

For More Details Circle (67) on Reply Card

8-Track Pre-Test

The **Fidelitone** 8-Track Pre-Test tape checks track switching, balance, and level for improved recording. Model 3058 is available in a blister pack suitable for peg hook hanging.

For More Details Circle (68) on Reply Card

Multi-Tip Head Demagnetizer

A universal head demagnetizer with interchangeable tips has been introduced by **Robins Industries**. Model 25011 is designed to eliminate the undesired build-up of residual magnetism that occurs in all recording heads during normal use of reel-to-reel cassette or 8-track equipment.

Model 25011 comes with one tip installed, and includes two other tips of different shapes which simply screw into place. A momentary-con-



trol switch is built into the flame-retardant, impact-resistant plastic case.

The demagnetizing process takes only seconds; recommended usage is after each 20 hours of play-record time. Model 25011 lists for \$15.00.

For More Details Circle (69) on Reply Card

Compact "Cube" Loudspeaker

Modestly priced, "Cube I" from **Sound West** features contemporary styling. Available in walnut veneer or natural oak, the compact speaker is furnished with a circular-shaped black acoustic foam grille, and a 5¼-inch, full-range, heavy-duty, ceramic-magnet speaker.

"Cube I" retails for \$19.95.

For More Details Circle (70) on Reply Card

More chances to be right



Thousands more
cross references



Transistor kit
for foreign sets



Replacement
amplifier modules



All the help you need
at your authorized distributor

Tube Products Department
General Electric Company
Owensboro, Kentucky 42301

GENERAL  ELECTRIC

Portable Stereo Cassette Machine

Featuring a special head design incorporating four tracks in-line and a photo-sensitive electronic control for the tape-drive mechanism, CR134 from **Uher of America** is a high-quality, compact cassette recorder.

In operation, the CR134 is versatile, and can be used as a stereo tape deck in a component system, for film synchronization, as a car stereo cassette deck, or, when used with batteries, as a portable tape machine.



The \$378.00 unit includes a built-in condenser microphone, disconnectable ALC, and a variable power supply.

Wow and flutter is less than 0.12% (RMS) and frequency range is from 25Hz to 15,000 Hz, within 2 dB. Signal-to-noise ratio is said to be better than 56 dB.

CR134 includes a carrying case, less batteries.

For More Details Circle (71) on Reply Card

Two-Channel Stereophonic Amplifier

According to **Bozak**, Model 929 audio amplifier produces continuous sine-wave power of 150 watts per channel into 8 ohms, from 20 to 20,000 Hertz at less than 0.2% total harmonic distortion.

Features of the amplifier include: instant, noiseless on/off; direct coupling of output to eliminate transformer distortions; protection for speakers against DC burnout and damaging subsonic impulses; thermal protection; electronic circuit protection to eliminate the need for fuses in the output circuitry; individual level adjustment for each channel; and pre-wiring for "bi-amp" operation.

Two versions are available. Model 929 sells for \$849.00, and includes one sound-power-level meter for each

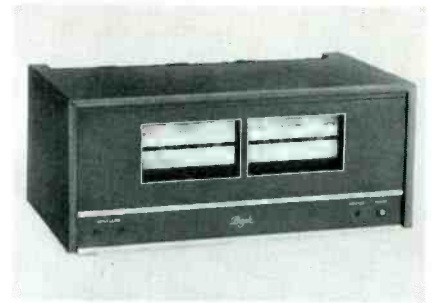

channel. Model 929-PV is priced at \$737.00 for use where meters are not required.

For More Details Circle (72) on Reply Card

Auto Stereo Speaker

Oaktron's 6-inch X 9-inch auto-stereo speaker designed for window-rattling volume, features power capacity to 40 watts RMS, with a 32-ounce Barium-ferrite magnet, which gives the speaker a 4 1/2-pound magnet structure.

The BF69TUV provides a response range of 40Hz to 16,000 Hz ± 3 dB, and has an 8-ohm, 1 1/4-inch voice coil on a moisture-proof and heat-resistant

aluminum form. The speaker also is available in 4 ohm.

For More Details Circle (73) on Reply Card

Record Washer

Spin-and-Clean record washer from **Fidelitone** cleans dirt and grease out of record grooves, removes static charge, and leaves no harmful residue.

For More Details Circle (74) on Reply Card



Rapid Rebate

Take this ad to your participating Raytheon Distributor and receive

A Free Raytheon 6GH8A Receiving Tube

with your purchase of \$15.00 or more (dealer cost) of Raytheon RE replacement semiconductors.

Raytheon RE – the only broad line of semiconductors that gives you all of these:

- individual packaging with replacement cross references printed on the bag
- comprehensive coverage of both domestic and foreign types
- listings in Sam's Photofacts®
- a complete reference guide and catalog

Plus a Rapid Rebate

Offer expires October 15, 1975. Good at participating distributors, or send proof of purchase to: Raytheon Company, DPO, 4th Ave., Burlington MA 01803

ES-7

For More Details Circle (15) on Reply Card

catalogs literature

Circle appropriate number on Reader Service Card.

100. Mountain West Alarm—announces a 96-page catalog describing over 450 intrusion and fire-alarm products. Equipment offered ranges from simple kits to ultrasonic, radar, and infrared intrusion detectors. Application, principle of operation, and specifications of products are included in the A-75 catalog.

101. Cleveland Institute of Electronics—makes available a booklet entitled **How You Can Get Your FCC License**. Answering the where, when, how, and why questions for obtaining an FCC license, the booklet covers basic requirements, and gives typical questions on the exam.

102. Kester Solder—covering the Kester line of solders, flux-core solders, and soldering fluxes, the 8-page catalog describes more than 50 solders and related items.

103. Advance Schools, Inc.—has published a 6-page pamphlet describing its radio and TV service course. Course topics and career opportunities are discussed briefly.

104. Data Technology Corporation—the brochure describes and illustrates Model 21, a palm-sized 3½-digit multimeter that measures capacitance, AC volts, DC volts, and resistance. The \$269.00 model is designed for field or bench operation.

105. Xcelite—bulletin 274 gives specifications and prices on a variety of new metric hand tools and sets from Xcelite.

106. Jersey Specialty Company—has issued a catalog featuring its line of wire and cable products. Included are illustrations and descriptions of coaxial cable, rotor wires, parallel cord, and speaker wire.

107. SGL Waber Electric—is distributing catalog No. 100 which features over 250 electrical power outlet strips, and 21 wheeled utility

carts.

108. Westinghouse—"Color Picture Tube Interchangeability Guide" is divided conveniently into two sections. The first section includes charts for each size and heater version of 90 degree color tubes, 19V-25V. A simple coding system shows which types are interchangeable. The other section is an alphabetical listing of all the tube types shown in the charts. The guide also provides safety tips on tube-replacement procedures and a history of color picture-tube development.

109. Switchcraft—containing more than 4,000 product listings, the short-form catalog provides product data and prices of major Switchcraft product lines including telephone jacks, plugs, switches, connectors, molded cable assemblies, and audio accessories. A numerical-alphabetical index shows the page number, column, and line number location of every product in the catalog.

110. Howard W. Sams & Co., Inc.—an 88-page catalog features more than 400 popular hardbound and paperback books. Topics include electronics, amateur radio, audio and hi-fi, mathematics, Audel do-it-yourself books on appliances, mechanical power, sheet metal, and others.

111. Littelfuse—an all-in-one automotive fuse-replacement guide covers both domestic and foreign automobiles and lists the manufacturer, year and model, protected circuits and accessories, fuse, fuse description, and normal mounting and location of the fuseholder.

112. Electronic Devices—describes silicon rectifiers such as bridges, axial lead, high-voltage packs, cartridges, Solid-Tube®, and other special device rectifiers. The short-form catalog contains 12 pages of electrical characteristics, dimensional drawings, and photos of the complete product line of rectifiers.

113. Fordham Radio Supply Company—this discount mail-order catalog includes tools, service and repair kits, tubes, test equipment, phono cartridges and needles, speakers and microphones, antennas, components and many other

servicing aids of major manufacturers. The catalog is illustrated and products are shown with discounted prices. □



"YOUR ARMS, MEDFORD, FLAP YOUR ARMS!
FASTER! FASTER!"

IT'S NO PUZZLE

TO ORDER

OELRICH SERVICE FORMS

FOR TV-RADIO & 2 WAY RADIO SERVICE LEGAL FORMS FOR CALIF. FLA. UTAH NOW AT YOUR PARTS JOBBER OR WRITE FOR CATALOG B64

OELRICH PUBLICATIONS

4040 N. NASHVILLE AVE.

CHICAGO, ILLINOIS 60634

For More Details Circle (16) on Reply Card

FREE ALARM CATALOG

Huge selection of burglar & fire systems, supplies. Motion detectors, infrared beams; controls, door switches, bells, sirens. 500 items. 99 pp. packed with technical details, notes.

(Outside U.S., send \$1.00.)

mountain west alarm

4215 n. 16th st., phoenix, az. 85016

For More Details Circle (17) on Reply Card

APPLIANCE REPAIR BOOKS

Written in easy-to-understand language by experts with illustrations & diagrams. Acclaimed by instructors & professionals. How to diagnose & repair air conditioners, refrigerators, vacuum cleaners, ranges, washers, dryers, steam irons, portable kitchen appliances, water heaters; plus how to set up a shop, using test instruments and more. Only \$2.65 to \$4.90 each!

SEND FOR FREE DESCRIPTIVE PRICE LIST

C & N, DEPT. ES, 5841 MONTROSE, CHICAGO 60634

For More Details Circle (18) on Reply Card



**BUY AMP®
CABLE TIES
BY MAIL!**

Up to twice as strong. Self-locking. Nylon with dual stainless-steel pawls. Four sizes. Various colors. Send \$1.00 for generous trial package 25 ties.

We'll include new AMP mail-order catalog free. Describes hundreds of electrical items for servicemen. Order from: Ties, Dept. 3005, AMP Special Industries, Valley Forge, PA 19482.



**AMP
SPECIAL
INDUSTRIES**

Division of AMP Products Corporation Valley Forge, Pa.

Offer expires
Sept. 1, 1975

For More Details Circle (19) on Reply Card 49

The MARKETPLACE

This classified section is available to electronic technicians and owners or managers of service shops who have for sale surplus supplies and equipment or who are seeking employment or recruiting employees.

Advertising Rates

in the Classified Section are:

- 25 cents per word (minimum \$3.00)
- "Blind" ads \$2.00 additional
- All letters capitalized 35 cents per word

Each ad insertion must be accompanied by a check for the full cost of the ad.

Deadline for acceptance is 30 days prior to the date of the issue in which the ad is to be published.

This classified section is not open to the regular paid product advertising of manufacturers.

FOR SALE

NEW Canadian Magazine "Electronics Workshop". \$5.00 yearly. Sample \$1.00. Ethko, Box 741, Montreal "A" Canada. 10-74-12t

UNUSUAL SURPLUS AND PARTS Catalog. \$1. ETCO Electronics Dept. E.S., Box 741, Montreal "A" H3C 2V2. 12-74-12t

LOW NOISE RESISTORS - 1/4W, 5%, carbon film from 10 - 3.3 Megohm for 3 1/2 cents. Fifty of one value for \$1.25. 1N4148 diodes for 6 cents. 75 cents postage. Free samples/specifications. Components Center-ES, Box 134, New York, N.Y. 10038 3-75-6t

HARD-TO-FIND TV & Radio Parts, New & Used. Ask Anyway. CMC 4329-4 Woodman, Sherman Oaks, Calif. 91423 3-75-6t

ADVERTISING PACKAGE FOR TV service shops. Inexpensive eye catching ads contain personal message from you-build customer confidence. Keeps your name before the public weekly. **PROVEN RESULTS.** Thirty ads with instructions \$19.95. Sample \$1.00 refundable. TV TIPS, 430 South Jefferson, Lebanon, Mo. 65536. 5-75-4t

DISCOUNTS TEST EQUIPMENT, parts. B&K, Sencore, RCA. B&K model 1246 color bar generator reg. \$156.00, now only \$132.60. Pomona 30KV high voltage probe \$29.95. Others, list 10. F&M Electronic Dist., P.O. Box 236, Dept. K, Masp. Qns., N.Y. 11378. 6-75-4t

ELECTRONIC 8 digit calculator: 25 keys, (\$33.00) refundable: durable, Tayo Paul, 980 Greene Avenue, Brooklyn, NY. 11221. 7-75-3t

SAM'S PHOTOFACTS 1 thru 1169. Good Condition. \$1500.00 Buys All. Paul Vaughn, 1702 N. College, Fayetteville, Ark. 72701, 501-442-6151. 7-75-11

CABLE TIES—6" Nylon - \$3.25/100pp. Ottinger, 106 Sheridan Ct., Leavenworth, KS 66048. 7-75-11

FOR SALE (CONT'D)

B-K 1465 SCOPE, Almost new, B-K 465 CRT Checker, RCA WV 77E V.T.V. M, EICO 369 T.V. Sweep Generator, Lafayette Cap-Res. Checker, 125 Sams, 296 Tubes in a caddy (List \$1,065.00). Retiring the lot for \$800.00. Charles Edward, Rt. 1, Box 574, Cottondale, Al. 35453. 7-75-11

FOR SALE: B & K Television Analyst (1077) - \$225.00. Heath Digital Multimeter (1M-1202) - \$70.00. Eico 460K Oscilloscope - \$95.00. All only one year old. Send Money Order or we will ship COD. William Sudderth, Route #1, Box 216, Murphy, N.C. 28906. 7-75-11

FOR SALE—HEATH—Various electronic instruments, stereos & TV's. All less than one year old. Must sacrifice for cash liquidity. Send for complete list—10%-40% off. Dave's Electronics, 824 Nob Hill Dr. W, Gahanna, Ohio 43230. 7-75-11

ANTIQUE "Most-Often-Needed 1926-1938 Radio Diagrams," \$7. Also 1941, 1942, 1948, \$4 each. Also single diagrams. Lawrence Beitman, 409-E Chalmers, Champaign, Illinois 61820. 7-75-11

HELP WANTED

JOURNEYMAN Technicians Wanted: \$8.00 per hour. Must be totally honest, non-drinking, non-smoker, clean appearance. Thoroughly modern shop, paid vacations, group hospital plan. Refund of moving costs for permanent employment. Send resume to American Television Service, 1032 So. State, Orem, Utah 84057. 7-75-3t

EDUCATION-INSTRUCTION

REPAIR TV TUNERS—High Earnings; Complete Course Details, 12 Repair Tricks, Many Plans, Two Lessons, all for \$2. Refundable. Frank Bocek, Box 3236 Enterprise, Redding, Calif. 96001. 6-75-4t

BUSINESS OPPORTUNITY

FOR SALE: TELEVISION & APPLIANCE SALES & SERVICE. Unbelievable opportunity—Maytag, RCA, Gibson and Monarch dealership, grossing \$100,000.00. Asking only \$15,000.00 plus inventory for cost. Will sell or lease 2000 sq. ft. building with large 3 bedroom apartment above. Same owner for 17 years will help establish new owner. Write P.O. Box 375, LaCrosse, Wis. 54601. 7-75-2t

advertisers' index

A & J Associates, Inc.	46
Amp Special Industries	49,53
B & K Div., Dynascan Corp.	7
Bussman Mfg. Div., McGraw-Edison	3
Castle TV Tuner Service, Inc. ...	Cover 4
Charous & Niebergall	49
Cleveland Institute of Electronics, Inc.	51
Gem City Tuner	10
General Electric Company	47, Cover 3
Heath Company	45
Hickok Electrical Instrument Co. ...	41
Mountain West Alarm Supply Co.	49,51
Oelrich Publications	49
Precision Tuner Service ..	51, Cover 2

Quasar Electronics Corp.	1
RCA Publications	17
Ratheon	48
Rohn Manufacturing	11
Sperry Tech, Inc.	16
GTE Sylvania - Consumer Renewal ..	9
Tech Spray	43
Tuner Service Corporation	5

Wanted!

700,000 busy executives who can:



If you can spend some time, even a few hours, with someone who needs a hand, not a handout, call your local Voluntary Action Center. Or write to "Volunteer," Washington, D.C. 20013.

We need you. 
The National Center for Voluntary Action.

 advertising contributed for the public good

↓ UP BOTTOMS



TAKE GE and Award Yourself!

Back by popular demand, GE Tube presents the 1975 version of BOTTOMS UP. It's *your* chance to cash in on a great gift bonanza, from now through November 30.

Start saving those familiar gray flaps (with the GE monogram) from the bottom of GE tube cartons. Also save the red or blue warranty serial number stickers (with GE monogram) from GE ULTRACOLOR® and Spectrabrite® color picture tubes. (One of these stickers is worth 20 gray receiving tube flaps. **75 flaps equal one book of S & H Green Stamps.**)

Your authorized GE Tube distributor has all the details in a colorful catalog crammed full of the gifts you want. He's waiting for you to come in and pick up your copy.

Your current inventory counts, so start saving *now*—and keep buying GE replacements to boost your total points. Get the details from your authorized distributor; he'll show you how to tear the bottom off GE!



BOTTOMS ↑

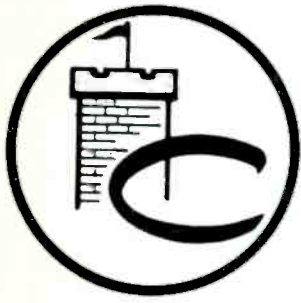

The Tuner People

*Pioneers of TV Tuner Overhauling
Originators of Complete TV Tuner Service*

Castle offers the following services to solve ALL your television tuner problems.

Universal Replacements from \$8.95

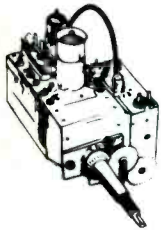

These universal replacement tuners are all equipped with memory fine tuning and uhf position with plug input for uhf tuner. They come complete with hardware and component kit to adapt for use in thousands of popular TV receivers.

STOCK No.	HEATERS	SHAFT		I.F. Snd.	PRICE
		Min.*	Max.*		
CR6P	Parallel 6.3v	1¾"	3"	41.25	8.95
CR7S	Series 600mA	1¾"	3"	41.25	9.50
CR9S	Series 450mA	1¾"	3"	41.25	9.50
CR6XL	Parallel 6.3v	2½"	12"	41.25	10.45
CR7XL	Series 600mA	2½"	12"	41.25	11.00
CR9XL	Series 450mA	2½"	12"	41.25	11.00

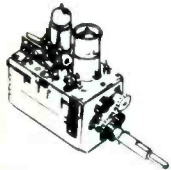
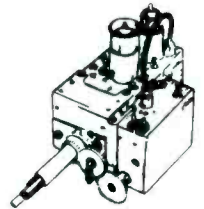

Castle Replacements \$15.95

Castle custom replacements made to fit in place of original tuner. Purchase outright . . . no exchange needed. Write for current list of Castle replacements, or request the part number you require (use number on ORIGINAL TUNER ONLY; do not use service literature numbers). Available for many of the popular models of following manufacturers: Admiral, Curtis Mathes, Emerson, GE, Heathkit, Magnavox, Motorola, Muntz, Philco, RCA, Sears, Sylvania, Westinghouse, Zenith and many private labels.

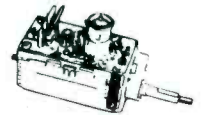

Overhaul Service \$9.95

This is the service pioneered by Castle! We are now in our third decade of serving the TV Service Industry

Service on all makes and models, vhf or uhf, including transistor and color tuners . . . one price \$9.95 Overhaul includes parts, except tubes and transistors.

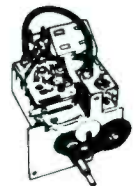

Remember!

Castle overhaul service is as near as your post office

Simply send us the defective tuner complete; include tubes, shield cover and any damaged parts with model number and complaint. Your tuner will be expertly overhauled and returned promptly, performance restored, aligned to original standards and warranted for 90 days.

Dismantle tandem uhf and vhf tuners and send in defective unit only. Remove all accessories . . . or dismantling charge will apply.

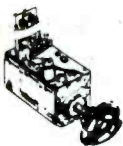
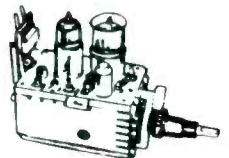

Custom Exchange Service \$17.95

When our inspection reveals that original tuner is unfit for overhaul, and it is not available from our stock of outright replacements, we offer to make a custom replacement on exchange basis. Charge for this service is \$15.95 for uhf tuner and \$17.95 for vhf tuner.

If custom replacement cannot be made we will custom rebuild the original tuner at the exchange replacement price.

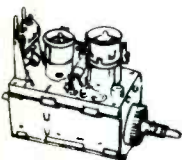
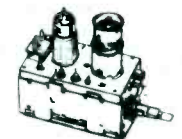

All replacements are new or rebuilt. All prices are f.o.b. our plant. Add shipping and handling of \$1.25 on all prepaid orders. We will ship C.O.D.



CASTLE TV TUNER SERVICE, INC.

5701 N. Western Ave., Chicago, Ill. 60645 • Ph. 312-561-6354

For More Details Circle (2) on Reply Card

